

Hybrid Security Alarm System User Manual

Table of Contents

1. INTRODUCTION	1
1.1 SYSTEM SPECIFICATIONS	2
1.2 WHAT'S IN THE BOX	4
2. PANEL INFORMATION	5
2.1. IDENTIFYING THE PARTS	5
2.2. POWER SUPPLY	9
3. GETTING STARTED	10
3.1. SELECTING MOUNTING LOCATION	10
3.2. MOUNTING	11
3.3. HARDWARE INSTALLATION	14
3.4. SOFTWARE INSTALLATION	25
4. CONNECTION TO PANEL WEBPAGE	28
5. DEVICE MANAGEMENT	29
5.1. LEARNING OF DEVICES	29
5.1.1. Add Sensor	29
5.1.2. Local Learning	30
5.1.3. Edit Devices	31
5.1.4. Delete Devices	35
5.1.5. Identify Device	錯誤! 尚未定義書籤。
5.1.6 Learning of Expansion Boards (WEZC-8)	35
5.2. ADD RF DEVICE	36
5.3. LEARN RULE	37
5.4. WALK TEST	39
5.5. EXCLUSION	40
5.6. SHUTTER CONTROL TOOL	41
5.7. PSS CONTROL	42
5.8. UPIC CONTROL	43
5.9. SURVEILLANCE	44
5.10. GROUP CONTROL	45
5.10.1. Group Control/Edit	45
5.10.2 Device Edit/Delete	45
5.11. SOUND/SIREN SETTING	46
5.11.1. Device Edit/Delete	46
5.11.2. RF Siren Setup	49
5.12. WIRED ZONES PROGRAMMING	50

6.	SYSTEM SETTINGS	56
6.1.	PANEL CONDITION	56
6.2.	PANEL SETTINGS	59
6.3.	PIN CODE	63
7.	NETWORK SETTINGS	64
7.1.	GSM	64
7.2.	NETWORK	67
7.3.	WIRELESS	錯誤! 尚未定義書籤。
7.4.	UPNP	68
8.	SYSTEM SETTINGS	69
8.1.	ADMINISTRATOR SETTING	69
8.2.	HOME AUTOMATION	70
8.3.	SCENE	75
8.4.	REPORTING	77
8.5.	CODE SETTINGS	80
8.6.	SMTP SETTING	82
8.7.	MEDIA UPLOAD	83
8.8.	POLLING	84
8.9.	XMPP	85
8.10.	DATE & TIME	86
8.11.	DYNAMIC DNS	87
8.12.	TEST IP	88
8.13.	FIRMWARE UPGRADE	89
8.14.	RF FIRMWARE UPGRADE	90
8.15.	IO MCU FIRMWARE UPGRADE	91
8.16.	FACTORY RESET	92
	8.16.1 Remote Reset	92
	8.16.2 Local Reset	92
8.17.	BACKUP & RESTORE	93
	8.17.1 Backup Data	93
	8.17.2 Restore Settings	93
8.18.	SYSTEM LOG	94
9.	EVENT & HISTORY	95
9.1.	CAPTURED EVENTS	95
9.2.	REPORTED EVENTS	96
9.3.	EVENT LOG	97
9.4.	DEVICE HISTORY	98
10.	APPENDIX	99

10.1. FAULT EVENT DESCRIPTION _____ **99**

10.2. CONTROL PANEL MODE AND RESPONSE TABLE _____ **100**

10.3. CROSS ZONE VERIFICATION _____ **102**

10.4. FIRE VERIFICATION _____ **103**

10.5. CONTACT-ID PROTOCOL & FORMAT _____ **104**

10.6. EVENT CODE _____ **105**

1. Introduction

The Hybrid Security Gateway is an IP-based multi-functional RF, smart home security gateway with 4G/LTE, plus 160 hardwired and wireless sensor zone options, providing comprehensive solutions, including remote management, home security, live visual monitoring, home automation, environmental emergency monitoring, and energy management and being designed to bring all-round convenience, comfort and safety.

System Feature

The Hybrid-Panel Series include the following models:

Name	Reporting Path	Modules
Hybrid-Panel-1-AC16/18V	IP/GPRS Reporting	IP Gateway supporting Sealed Lead-Acid (SLA) rechargeable battery pack (battery not included)
Hybrid-Panel-1-AC110/240 V	IP/GPRS Reporting	IP Gateway supporting Sealed Lead-Acid (SLA) rechargeable battery pack (battery not included)

1.1 System Specifications

Functions	
Number of areas	2
Number of on-board wired zones	16 on-board zones, expandable to up to 64 ¹ zones in total
Number of total wired and wireless zones	80 per area, 160 in total
Zone expansion module	8 wired zone expansion module (WEZC-8) available
Number of wired keypads (KPT-35-COMBO)	32 (via RS-485 connection)
Number of users	80 per area, 160 in total
Wired input	NO/NC Single end-of-line (SEOL) Double end-of-line (DEOL) EOL resistance configuration (in ohms): 1K, 2.2K, 3.74K, 4.7K, 5.6K, 6.8K, 8.2K, 10K (32 pieces of 5.6K resistors are included in shipment)
Ethernet interface	RJ-45 connection
Electrical	
Power supply ¹	(1) 16 ~ 18VAC, 40VA, 50/60Hz (2) 100 ~ 240VAC, 50/60Hz
Total current consumption of hardwired zones, auxiliary output, KPT-35-COMBO and expansion module	12V/400mA (max.)
PGM & Bell total output	12V/400mA (max.)
Backup battery ² options	(1) 12V/7A Sealed Lead Acid Battery (can be expanded up to 2 pieces) (2) 12V/4A Sealed Lead Acid Battery (can be expanded up to 2 pieces)
Battery duration	(1) 12V/7A SLA: 36 hours (2) 12V/4A SLA: 21 hours

¹ Only one of these three options can be adopted at one time

Wireless	
LTE Frequency	US: B2 (1900 MHz) / B4 (1700 MHz) / B12 (700 MHz)
3G Frequency	US: B2 (1900 MHz) / B4 (1700 MHz) / B5 (850 MHz)
RF Frequency	F1 919 MHz
RF encryption	Private Encryption Method
RF protocol	Climax
Physical Properties	
Operating temperature	-10°C to 45°C (14°F to 113°F)
Operating humidity	85% relative humidity @23°C (non-condensing)
Dimensions	268 mm x 320 mm x 80 mm

1.2 What's in the Box

Your package includes the following items:

- Control Panel

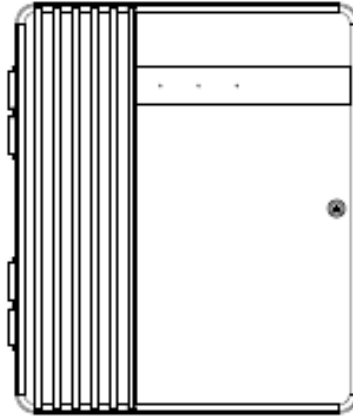

- Open Frame Power Cord



- An Ethernet Cable

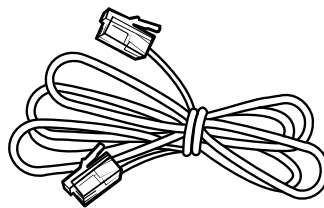

- Accessories:

- ☞ Velcro tape x4
- ☞ Jumper Switch x2
- ☞ Removable Protective Cover x4
- ☞ U-shaped Grommet x4
- ☞ 5.6K Resistor (2 resistors for each zone, 32 resistors for 16 zones in total)
- ☞ Screw x4
- ☞ Wall Plug x4
- ☞ Tube Fuse x1 (for SLA Battery Panel Only)
- ☞ Power Cable x1

2. Panel Information

2.1. Identifying the parts

Top Cover (front view)

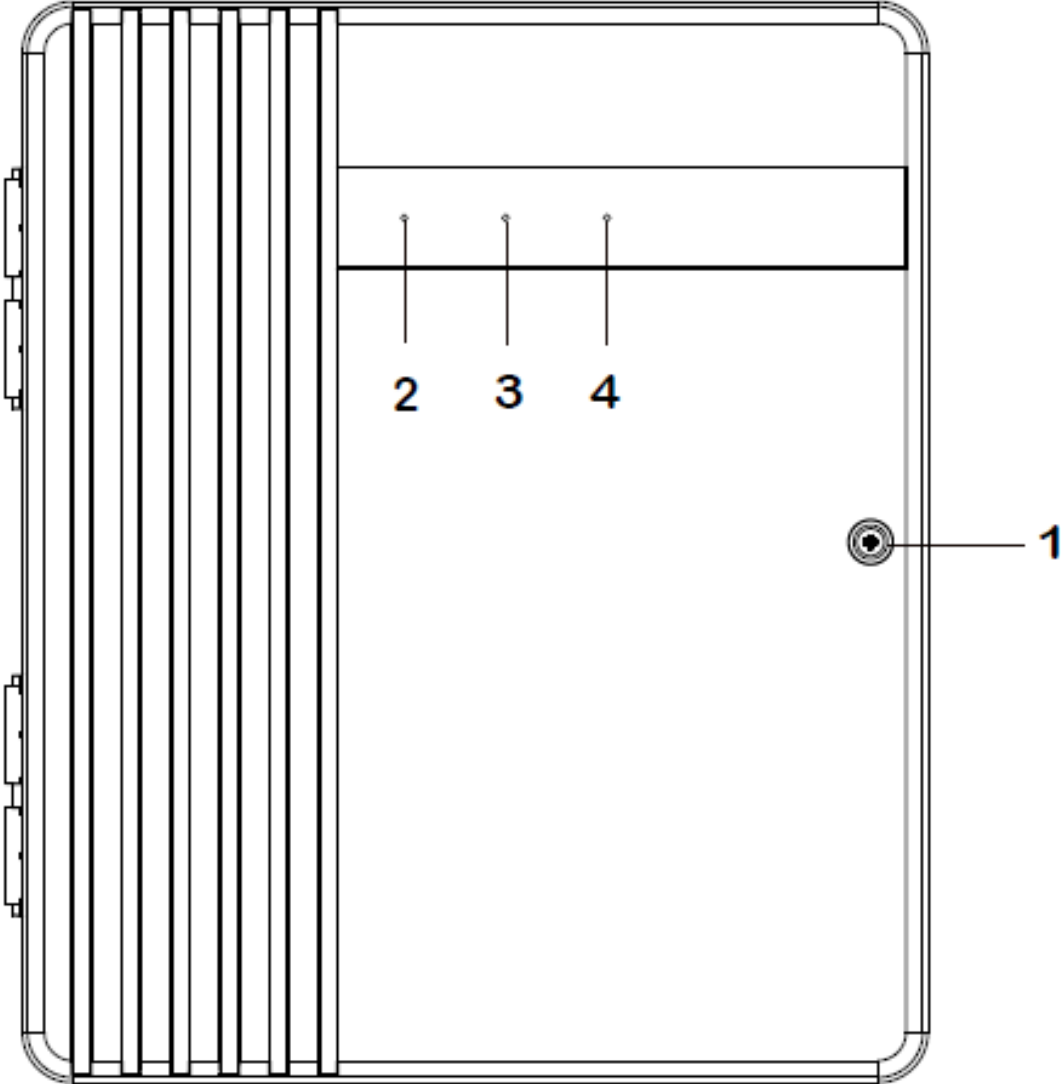

Back Cover (internal view)

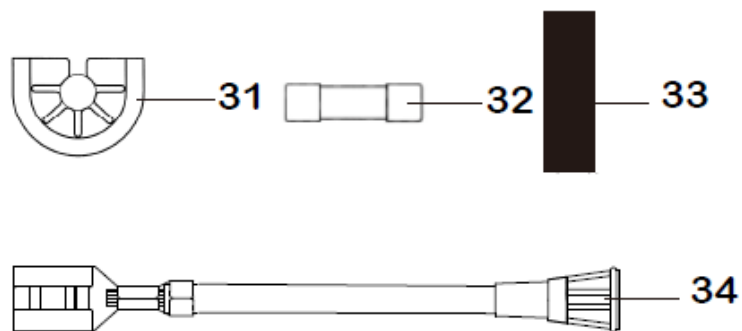
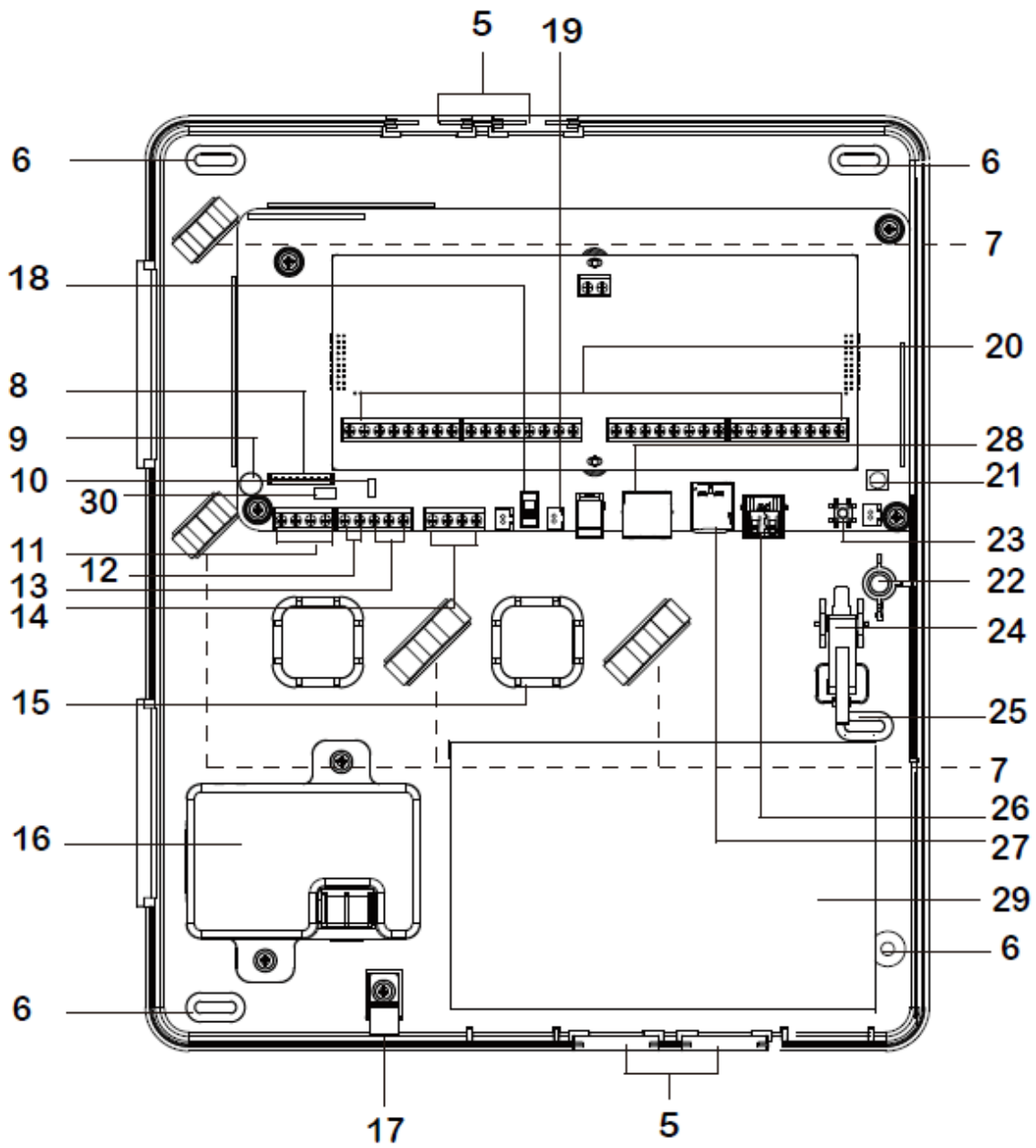

1 Cover Fixing Screw

2 LED 1 - Area 1 (Green/Red)

- ☞ Full Arm mode - Red lighting up
- ☞ Home/1/2/3 mode - Red flashing
- ☞ Learning mode - Green lighting up
- ☞ Walk Test mode - Green flashing

3 LED 2 - Area 2 (Green/Red)

- ☞ Full Arm mode - Red lighting up
- ☞ Home/1/2/3 mode - Red flashing
- ☞ Learning mode - Green lighting up
- ☞ Walk Test mode - Green flashing

4 LED 3 - Status (Orange/Red)

- ☞ System Fault - Orange lighting up
- ☞ Alarm Trigger – Red flashing
- ☞ Alarm in Memory – Red lighting up

5 Removable Protective Cover x 4 (at top and bottom of the back cover)

Removable cover to reveal or hide cable wiring hole.

6 Mounting Holes x 4

7 Wiring Clip x 4

8 LED Board Connector

9 EGND Terminal

Please refer to **3.3 Hardware Installation** for detail.

10 J24 Jumper Switch

Please refer to **3.3 Hardware Installation** for detail.

11 RS485 Terminal

Connect to a hardwired keypad (KPT-35-Combo), or wired expansion module (WEZC-8). Up to 32 hardwired KPT-35-Combo can be connected in parallel.

12 Bell Terminal

Connect to a wired bell box for bell wiring.

13 PGM Port

To be used as a voltage output port or a dry contact relay output depending on J24 jumper settings.

14 SLA Backup Connection Battery Terminal (not hot swappable)

Connect to SLA battery pack, up to two battery packs can be connected.

15 Alternative Hole for Wiring Management x 2

16 Built-in Power Unit (Input: 16 ~ 18VAC 40VA or 100-240VAC)

AC module built-in power unit or Open Frame built-in power unit is installed. Use the built-in power unit to connect to the mains power.

☞ **Ensure to turn off all power supplies including Built-in Power Unit and SLA Battery before connecting or removing cables or wires.**

17 Wire Saddle

To be used for securing power cables.

18 Battery Switch

Switch to “ON” for the battery to be charged when AC power is connected and serve as a backup power source when AC power is missing.

19 Built-in Power Unit Connector

20 Zone Terminal & 12V Auxiliary Voltage Output Terminal & GND Terminal

Zone 1-16 Hardwired Input Zones, supporting up to 400mA for all hardwired zones, auxiliary output and KPT-35-COMBO.

21 4G-LTE External Antenna Terminal

For connecting external antenna to the panel.

 **Do not disconnect the internal antenna when connecting the external antenna. To switch between the use of internal or external antenna, please configure through software setting. See chapter 7.1, GSM for details.**

22 Internal Antenna Terminal

23 Learn Button

To be used for local learning or local reset.

24 Tamper Switch

To protect the Control Panel against disallowed case opening or removal.

25 Tamper Screw Hole

To be used for securing tamper proof screw.

26 USB Port (optional)

When connecting a USB dongle into the port, it is suggested to use a USB extension cable. There is no USB Port for the panel if it is built in 4G.

27 Micro-SIM Card Socket (not hot swappable)

28 Ethernet Port

29 Room for SLA Battery Pack

Room for installing 12V 7A rechargeable battery pack.

30 J53 Jumper Switch

J53 Jumper Switch can be served as a terminating resistor, which can be turned to ON when wiring different devices to the panel to enhance connection.

31 U-shaped Grommet x 4

To be used to replace the Removable Protective Cover to enhance wiring and cord management flexibility. Ensure to save the Protective Cover removed for future use.

32 Tube Fuse

250Vac 2A fuse for circuit protection.

33 Velcro Tape x 4 (loop side)

To be applied on the battery pack for easy battery installation and connection.

34 In-line Tube Fuse Holder

2.2. Power Supply

Built-in Power Unit

- You can use the built-in power unit to connect to the mains power. AC module built-in power unit or Open Frame built-in power unit is installed. Please refer to ***Using the built-in Power Unit*** in ***3.3 Hardware Installation*** for more details.

Please note:

- ☞ **Ensure to turn off all power supplies including Built-in Power Unit and SLA Battery before connecting or removing cables or wires.**

Rechargeable Battery

- A rechargeable battery can be installed inside the Control Panel to serve as a backup in case of a power failure.
- During normal operation, AC power is used to supply power to the Control Panel and at the same time recharge the battery.
- If the battery switch is set as **OFF**, the battery will not be charged when AC power is connected and nor will it serve as a backup power source when AC power is missing. You need to switch the battery to **ON** for it to be charged when AC power is connected and serve as a backup power source when AC power is missing.

3. Getting Started

Read this section of the manual to learn how to set up your Control Panel.

3.1. Selecting Mounting Location

The Control Panel is designed to be wall mounted and protected against unauthorized case opening or removal from its mounting surface, follow guidelines below when planning installation location:

- The Control Panel requires the mains power and Ethernet connection.
- If a Cellular Module is used, ensure that there is good cellular coverage (Advisable to have a level of at least 4 out of 5).
- The Control Panel needs to have access to the routing of cables for the system to connect with wired devices.
- A central location between all the devices is often the best place, making wiring to expanders or devices easier, and preferably a place that is hidden from outside view.
- Avoid mounting the Control Panel in a damp location, close to a heat source, or near large metal objects, which may affect wireless radio strength.
- The Control Panel should be protected by sensors so that no intruder can reach the Control Panel without first activating a sensor.

3.2. Mounting

Before installation or any maintenance work, make sure the power supply has been disconnected, and the battery switch has been slid to OFF position.

Step 1. Use a flat-head screwdriver to loosen the cover fixing screw to open the top cover.

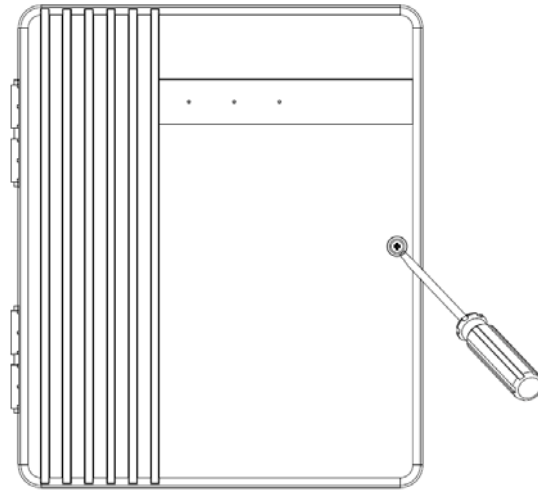

Step 2. Use the 4 mounting holes as a template to mark and drill holes appropriately.

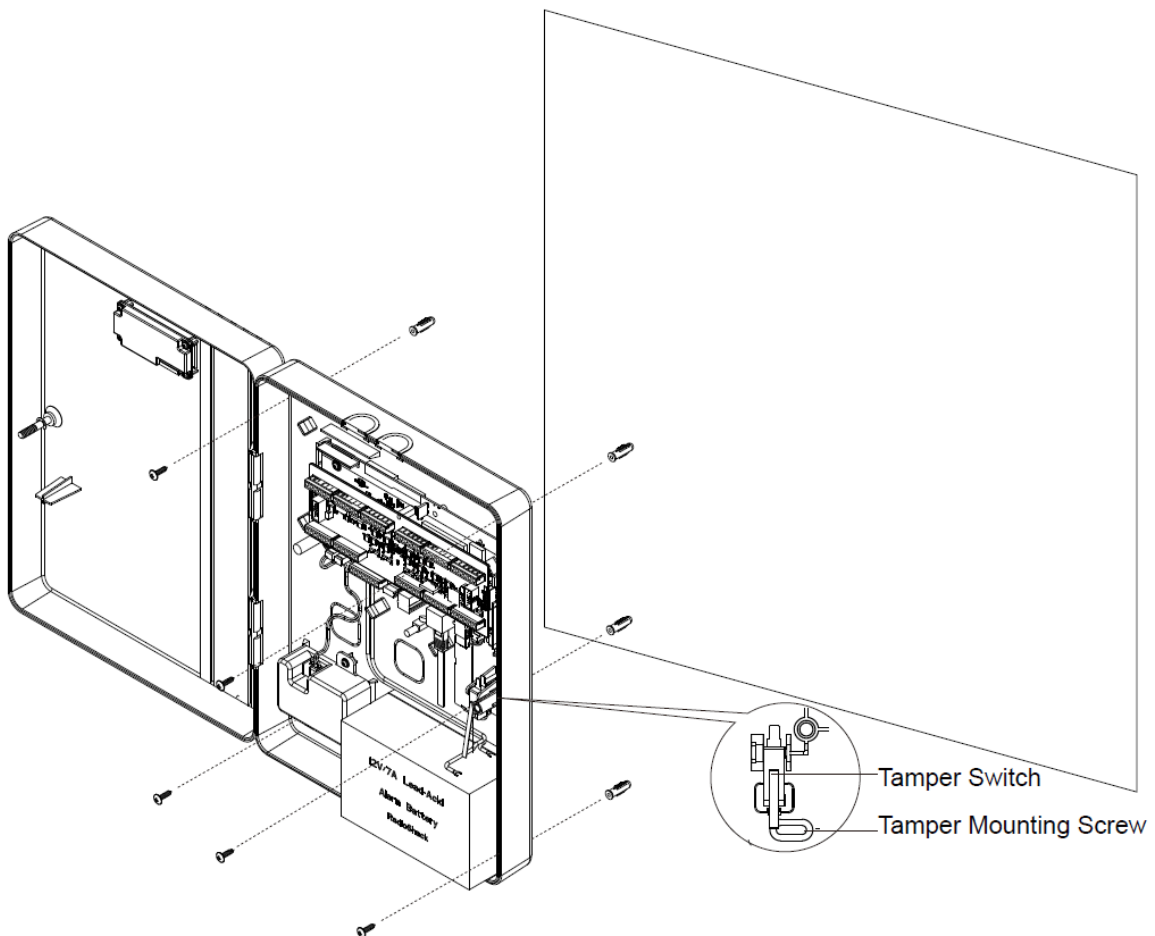

Step 3. Use the provided wall plugs for plaster/brick installation. Make sure the wall plugs are flush with the wall.

- Step 4.** Screw the Control Panel onto the wall. Make sure the Tamper Switch is fully depressed against the wall.
- Step 5.** Take out Velcro tape(s) from the package. Please note: The number of Velcro tape(s) required may vary depending on your battery type and capacity.
- Step 6.** Peel the release film of the tape. Apply it to your battery pack and press firmly for 30 seconds to ensure good contact. Please avoid applying the tape on uneven surface or re-apply it.

<NOTE>

- Apply the Velcro tapes to the back of the battery pack for long-term attachment

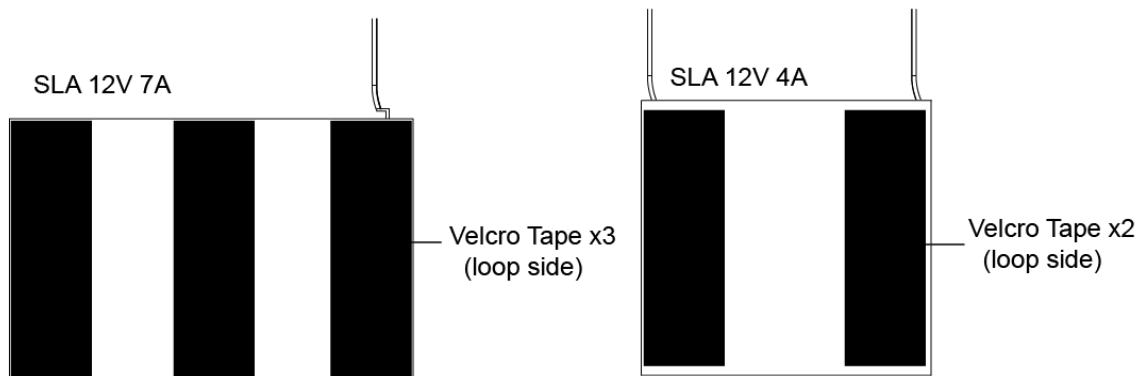

- Step 7.** Complete wiring following the instructions in later section **3.3. Hardware Installation.**
- Step 8.** Arrange all wires along the wire clips and then route the wires to the two cable holes on top. Use cable ties (not included) to thread through the wire clips and secure the wires. Use the U-shaped grommets around the cable holes to manage wires.

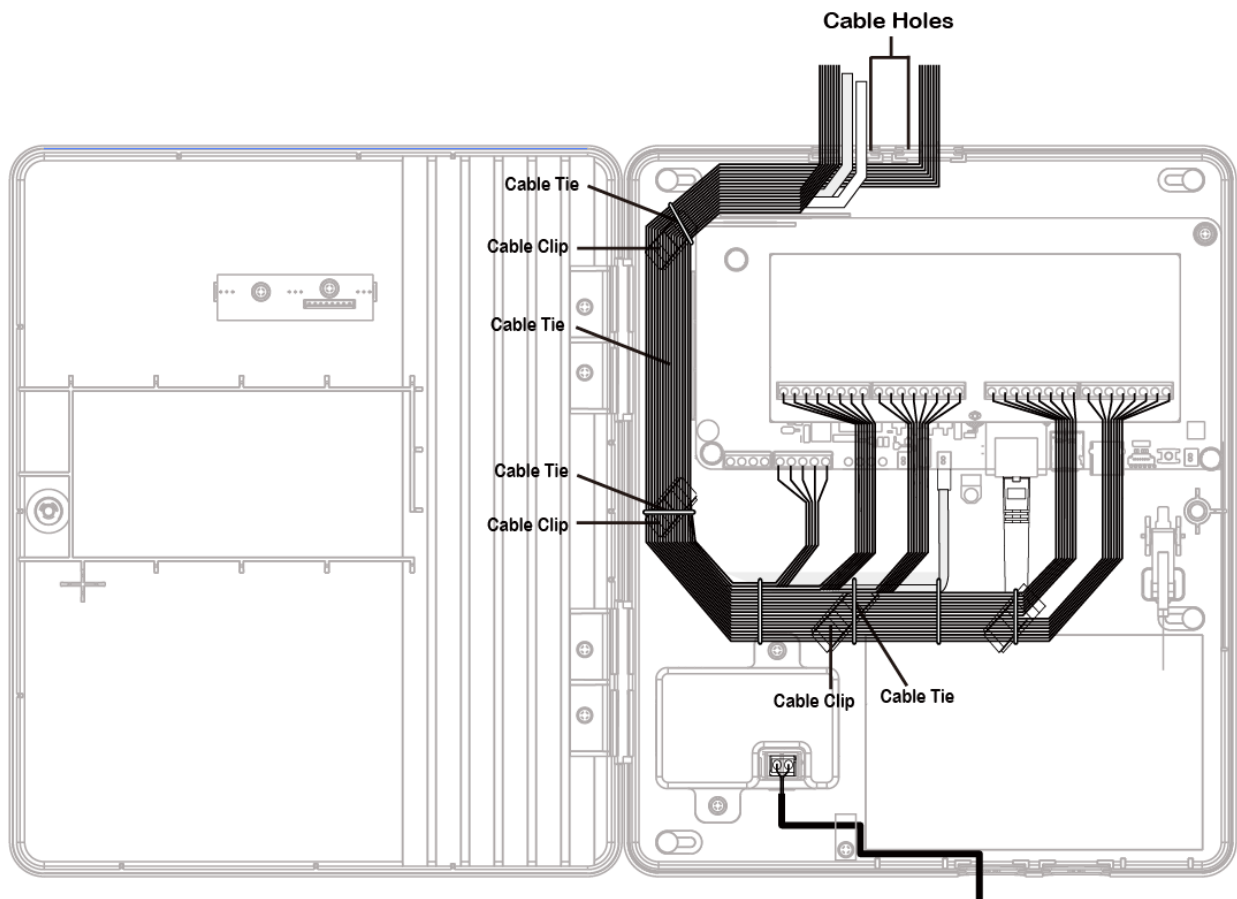

Step 9. Close the cover and tighten the cover fixing screw.

3.3. Hardware Installation

CAUTION: Before servicing, make sure the AC power has been disconnected, and the battery switch has been slid to OFF position.

- Step 1.** For configuration and operation of the Control Panel via Ethernet, connect an Ethernet cable to RJ-45 port.
- Step 2.** (Optional) Insert a Micro-SIM card with the gold (metal) side facing down, as example shown below. Before inserting the SIM card, please make sure the pin code is deactivated and SMS messages are removed first.

<NOTE>

- Before inserting the SIM Card, please power off the panel.
- Please make sure to insert a SIM card with data plan.
- After inserting the SIM Card, please power on again.

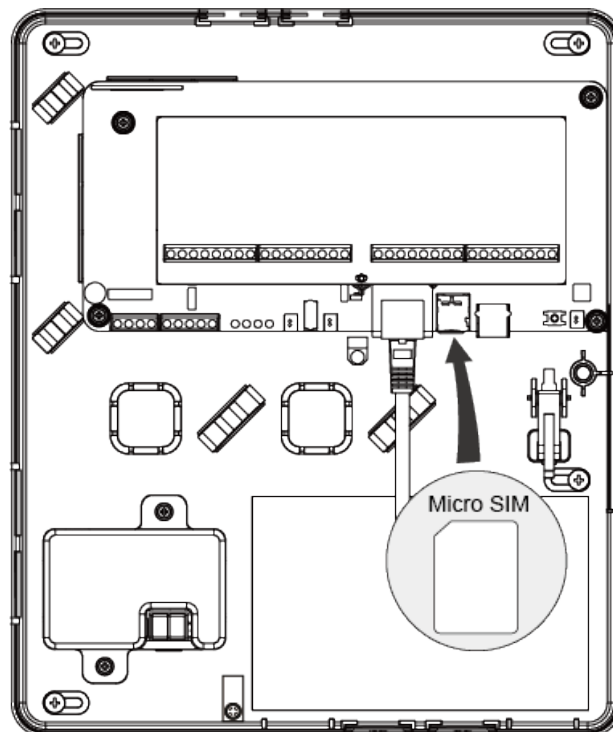

- Step 3.** Complete wiring for Zone 1-16 terminals, GND terminals, AUX power terminals, PGM terminals, Bell terminals, and Keypad terminals. (Please see the following sections for details.)
- Step 4.** Connect the battery pack to the PCB board.
- Step 5.** Connect to the mains power using the built-in power unit.
- Step 6.** (Optional, for SLA battery) Take out the in-line tube fuse holder from the package. Place the tube fuse inside the holder and screw it.
- Step 7.** (Optional, for SLA battery) Attach the black cable from Hybrid Panel board to the SLA battery terminal (the negative polarity). Attach the red cable from Hybrid Panel board to the SLA battery red connector (the positive polarity).
- Step 8.** Slide the battery switch to ON position.

Zone Wiring (Zone 1 -16)

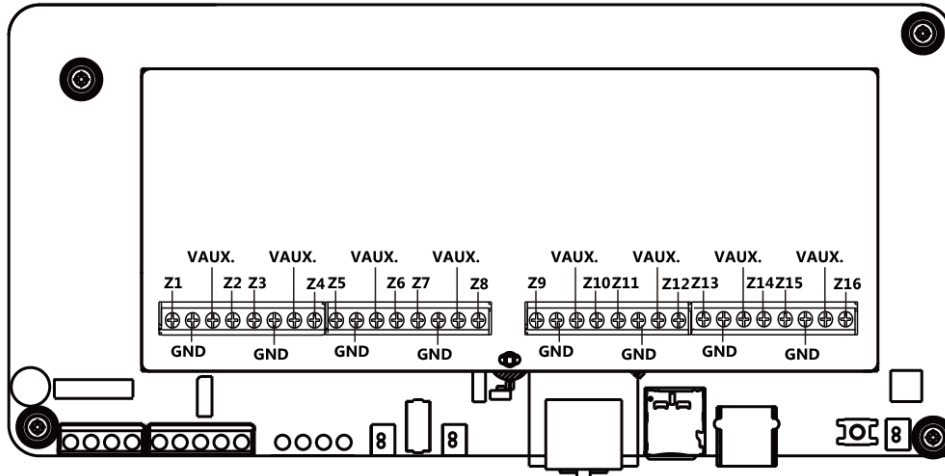

- The 16 zones can be wired by supervising NC (normally close) or NO (normally open) devices, e.g. PIR sensor, door contact, smoke detector, water sensor, fire sensor, CO sensor, gas detector, heat detector, and glass break detector, etc.
- Wire gauge: Minimum 20 AWG, maximum 18 AWG. Do not use shielded wire.
- The hardwired zones support Single-End-of-Line (SEOL) or Double-End-of-Line (DEOL) loop configuration, with a value from 1K, 2.2K, 3.74K, 4.7K, 5.6K, 6.8K, 8.2K, 10K ohms. Please install the resistor(s) at the end of each zone loop far away from the Control Panel. The Panel will detect if the circuit is secure, open, or short.
- For an NC loop, please have an EOL resistor in series with the loop.
- For an NO loop, please have an EOL resistor in parallel (across) the loop. Please refer to the following diagrams for wiring examples.
- There is no EOL resistor in loop 1 and loop 2.

NO/NC Wiring

1.

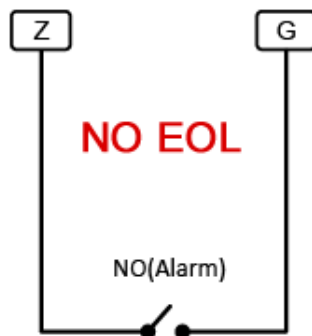

2.

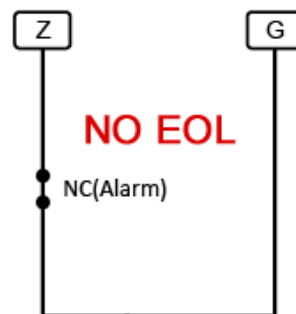

Single-End-of-Line Resistor Wiring

3.

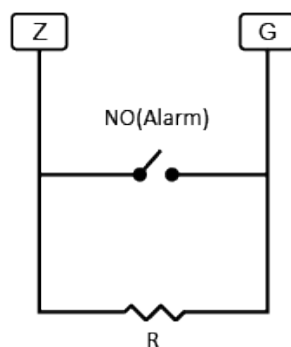

4.

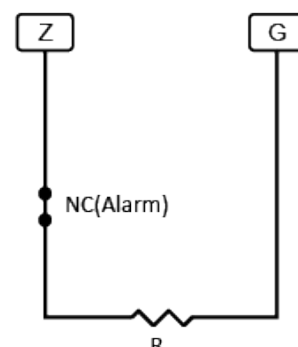

5.

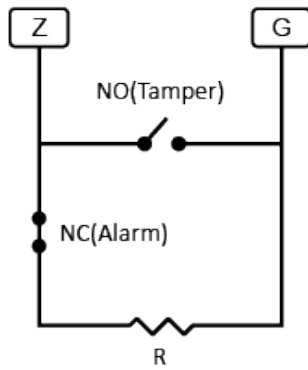

6.

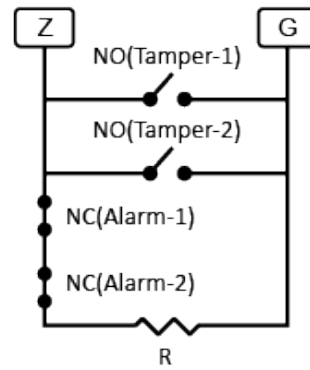

Double-End-of-Line Resistor Wiring

7.

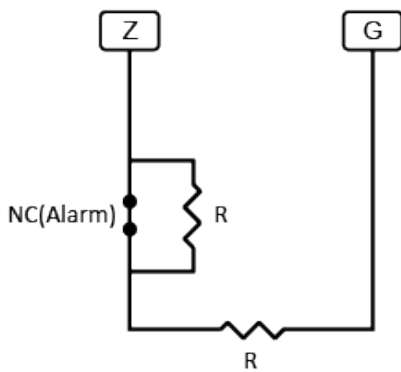

8.

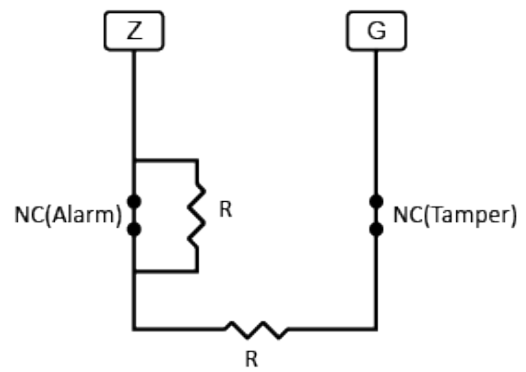

AUX Power Wiring

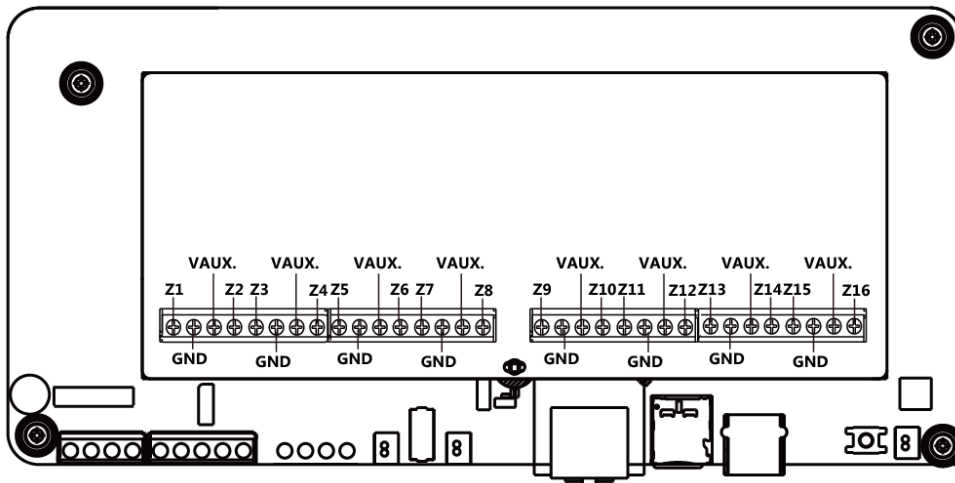

- The Control Panel can provide a maximum of 12V 400mA current for hardwired zones, auxiliary output, KPT-35-COMBO and wired expansion module (WEZC-8).
- Min/Max operating voltages for devices/detectors is 11.4VDC -13VDC.
- Please note that the total current should **not exceed 400mA**, otherwise, an additional power supply is required.

PGM Wiring

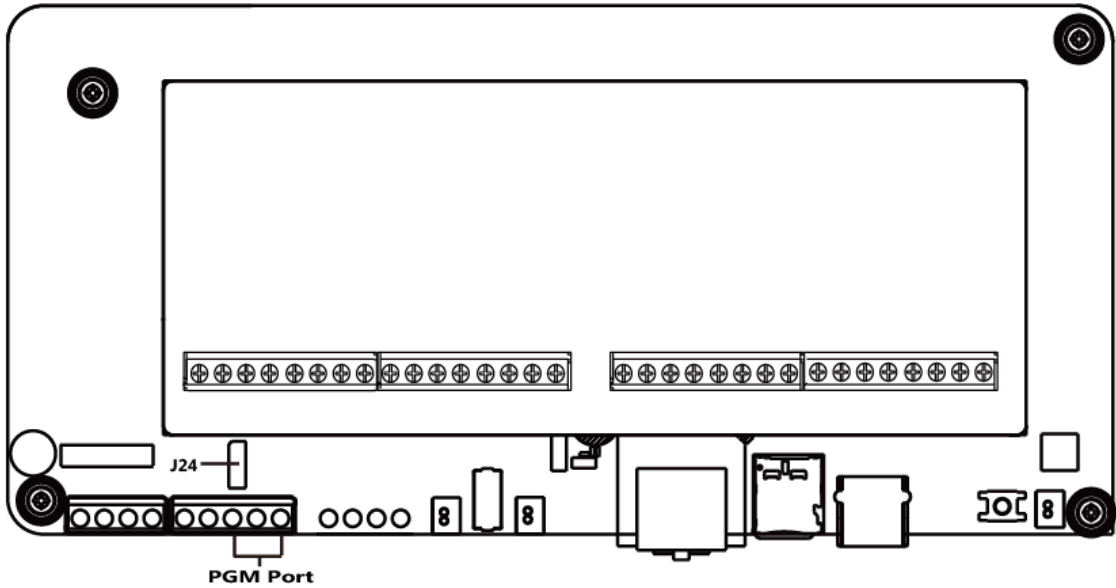

- The PGM port can be a voltage output port or a dry contact relay output depending on J24 jumper settings.
- When J24 Jumper Switch is disconnected, PGM port will operate as a dry contact relay output.

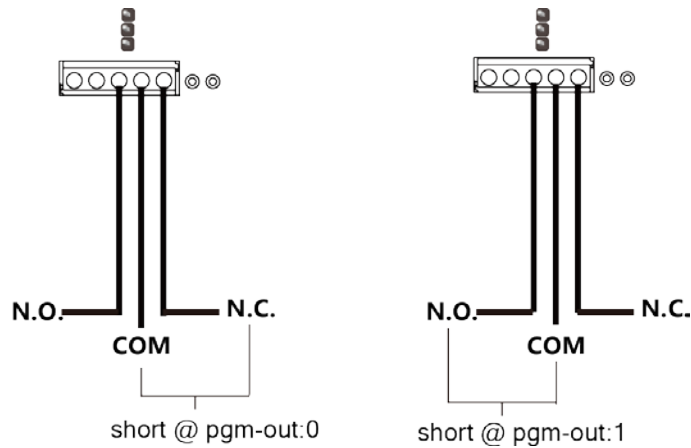

- When the J24 jumper link is inserted connecting the 1st and 2nd pins, the PGM port will provide 12V output.
- When the J24 jumper link is inserted connecting the 2nd and 3rd pins, the PGM port will provide 0V output.
- The total current drawn from the PGM and Bell port combined must **not exceed 400mA**. Min/Max operating voltages for devices / detectors is 11.4VDC -13VDC.

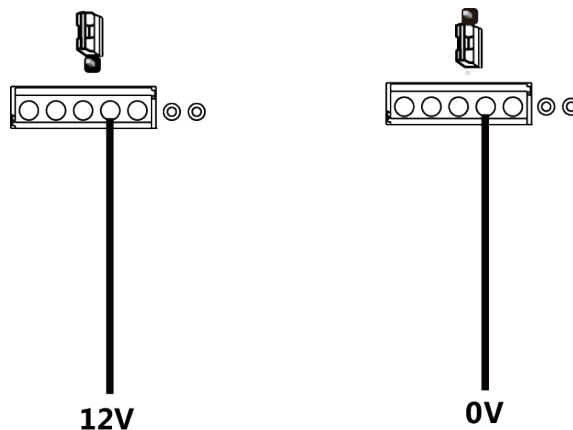

Wired Zone Expansion

- Hybrid Security Alarm System is compatible with HWC-1 Wireless Converter. One HWC-1 can add 9 wired zones to the Control Panel.

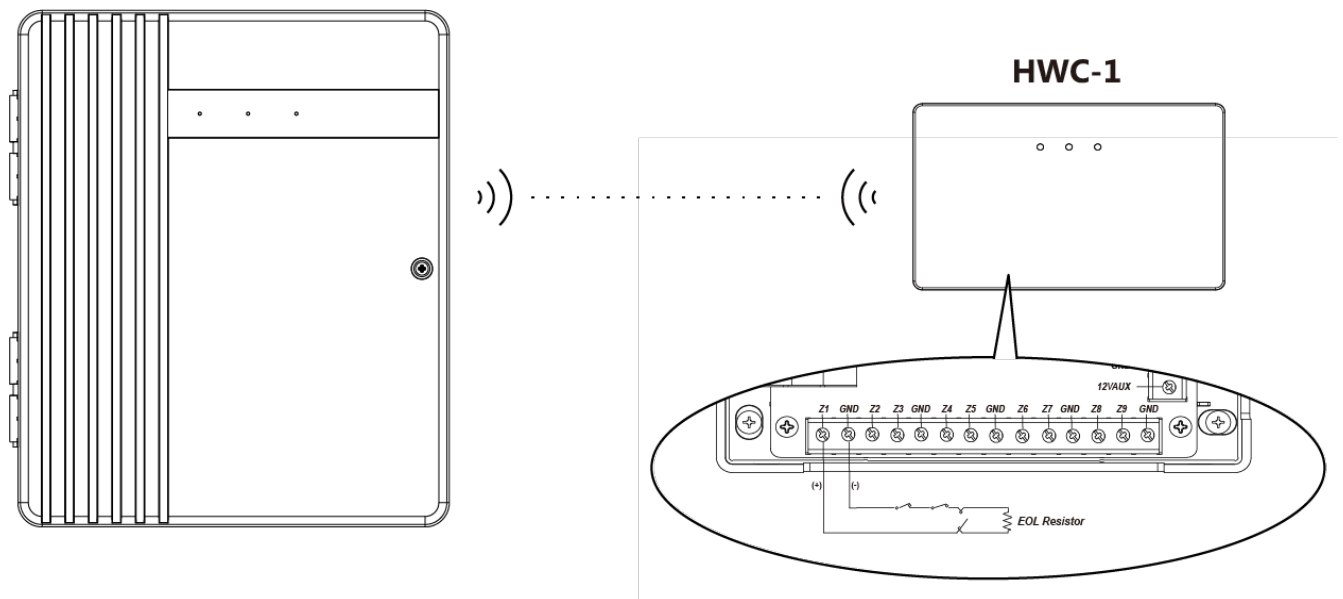

Bell Wiring

- The total current drawn from the Bell and PGM port combined must **not exceed 400mA**. Min/Max operating voltages for devices / detectors is 11.4VDC -13VDC.
- Be sure to observe polarity when connecting polarized sirens or bells.

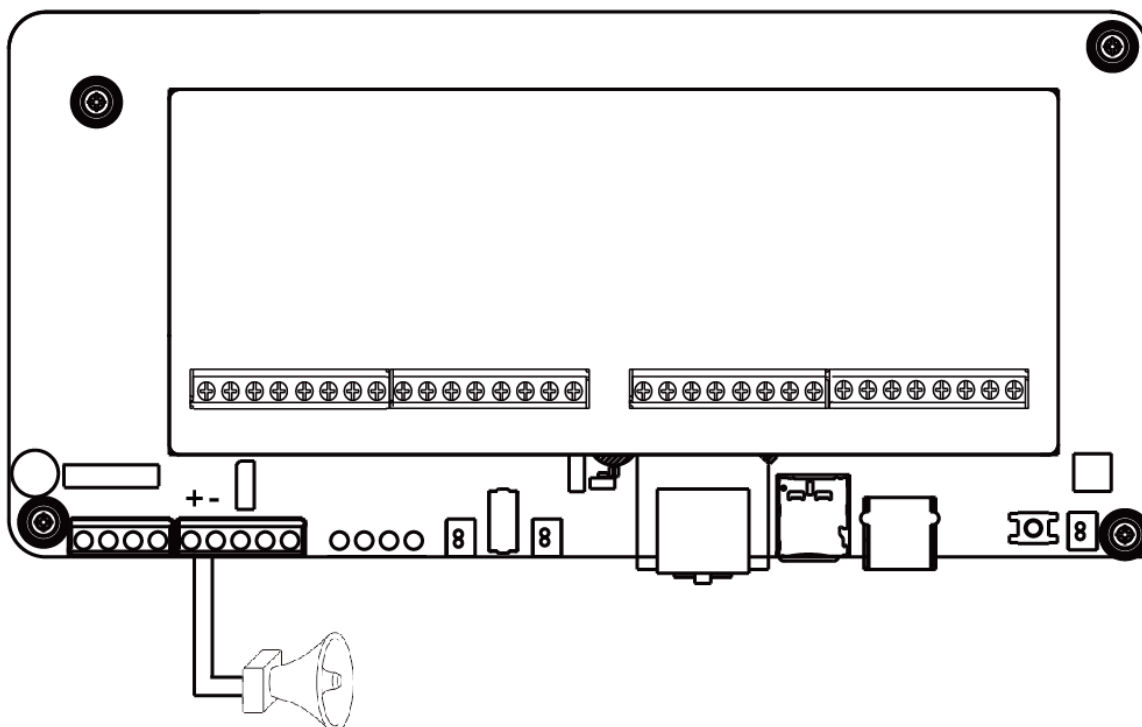

Connecting Other Devices to Panel

Compatible keypad (KPT-35-Combo) and expansion module model (WEZC-8) can both be wired to the panel at the same time.

For Keypads:

Panel/Keypad Connection:

- Connect the Control Panel's "GND" to the "G" terminal on the KPT-35-COMBO.
- Connect the Control Panel's "485A" to the "A" terminal on the KPT-35-COMBO.
- Connect the Control Panel's "485B" to the "B" terminal on the KPT-35-COMBO.
- Connect the Control Panel's "VDD" to the "V" terminal on the KPT-35-COMBO.

Daisy Chain Connection Between Keypads:

- Connect the keypad's "A" to the "A" terminal on the other keypad
- Connect the keypad's "B" to the "B" terminal on the other keypad.
- Connect the keypad's "G" to the "G" terminal on the other keypad.
- Connect the keypad's "V" to the "V" terminal on the other keypad.

For Expansion Boards:

Expansion Board Connection:

- Connect the four terminals labeled as **VDD**, **GND**, **485A**, **485B** of the module to the corresponding terminals on the hybrid panel.

Daisy Chain Connection Between Expansion Board:

- The daisy chain connection method is the same for daisy chain connection when adding more expansion modules.

Connection between Keypad and Expansion Board:

- Connect the WEZC-8's "GND" to the "G" terminal on the KPT-35-COMBO.
- Connect the WEZC-8's "485A" to the "A" terminal on the KPT-35-COMBO.
- Connect the WEZC-8's "485B" to the "B" terminal on the KPT-35-COMBO.
- Connect the WEZC-8's "VDD" to the "V" terminal on the KPT-35-COMBO.

Wiring Example

- KPT-35-COMBO is wired correctly as it is within 500' / 152m of the panel, in wire distance.
- WEZC-8 (A) is wired correctly as it is within 800' / 244m of the panel, in wire distance. Since it has the furthest distance from the Control Panel, ensure its jumper switch is set to ON to serve as a terminating resistor before tightening the cover fixing screw.
- WEZC-8 (B) is NOT wired correctly as it is farther than 1300' / 396m from the panel, which makes it exceed the total length of wiring of 1000 feet.
- Ensure the furthest keypad or expansion module's Jumper Switch and Control Panel's J53 Jumper Switch are set to ON to serve as a terminating resistor.

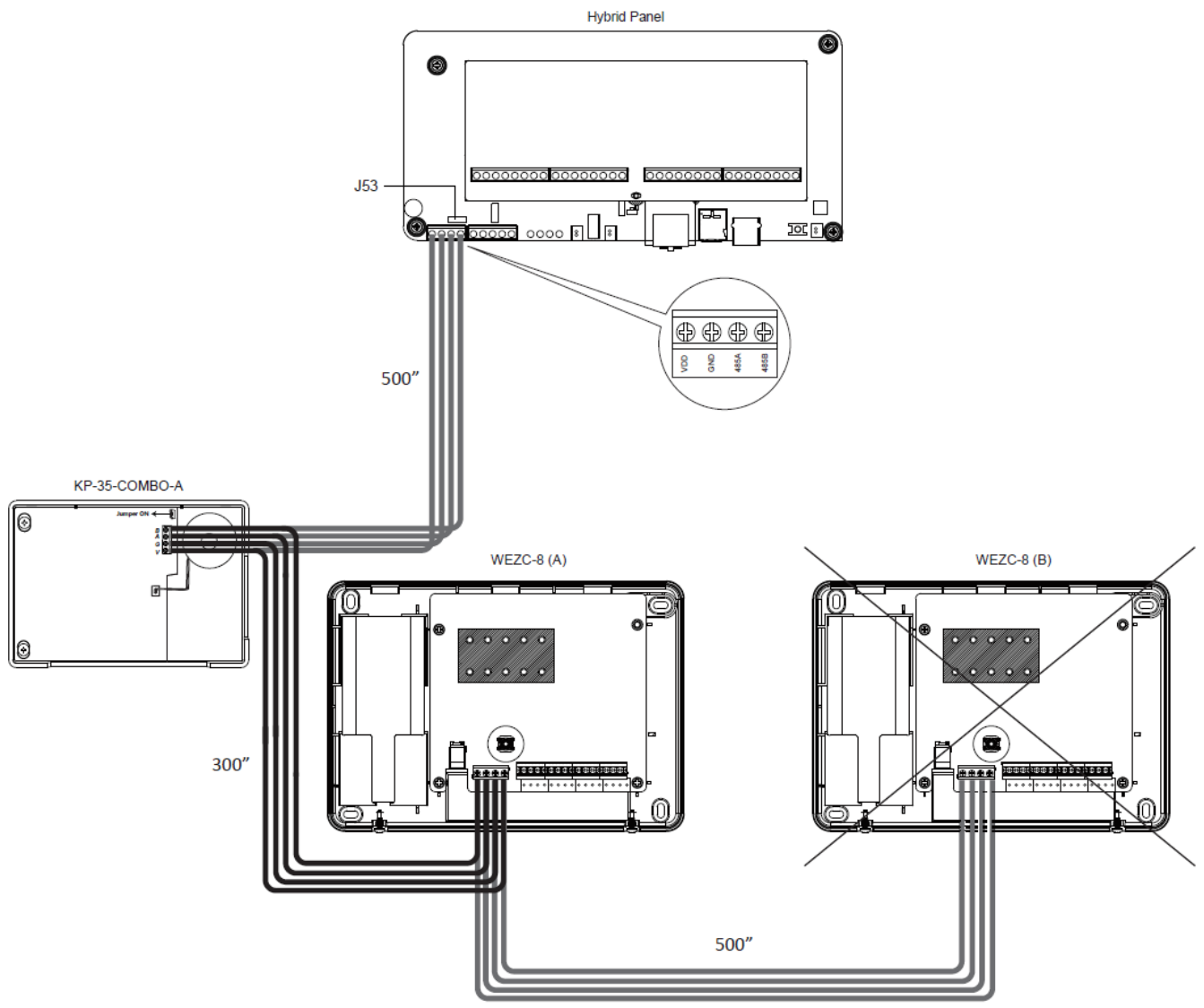

- As the Hybrid Panel may be connected to multiple external devices, be sure to ensure the power supply is adequate for all connected devices.
- For example, if the 12V power supply from the main control panel is only enough for the first connected device, please prepare an external power supply to ensure the rest of the connected devices receive enough power.

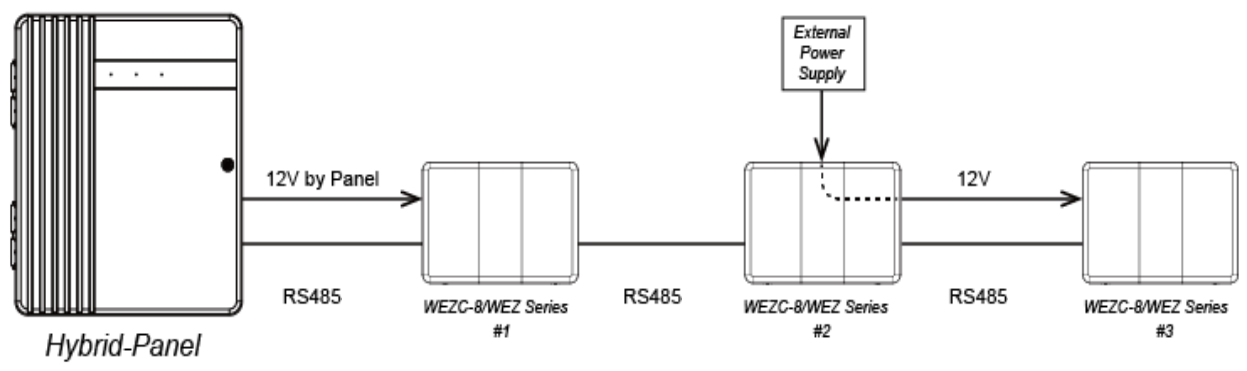

Ground Wiring

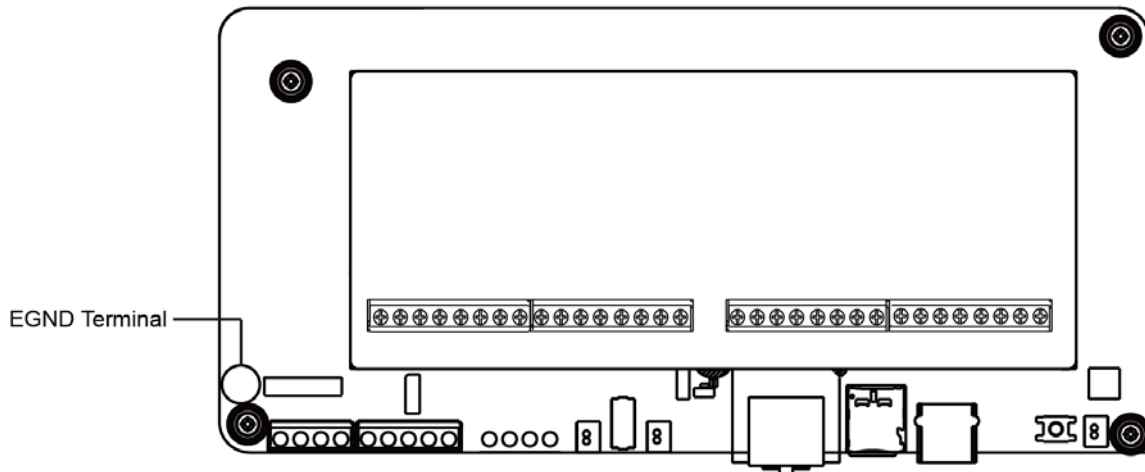

- Using an insulated green wire (minimum 22 AWG), connect the EGND terminal and the grounding wire from the building electrical installation.

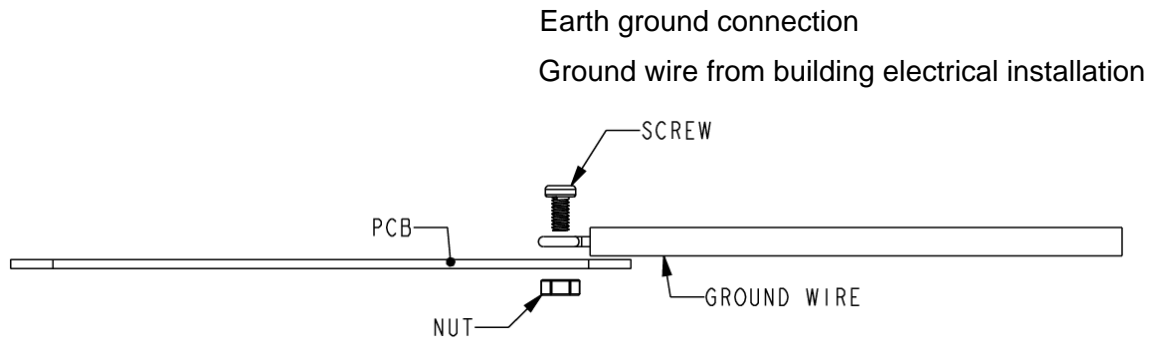

Battery Installation

- The Control Panel can support up to two SLA rechargeable battery packs to serve as a backup power source.
- Battery options include:
 - 1) One or two 12V/7A SLA battery pack;
 - 2) One or two 12V/4A SLA battery pack;

<NOTE>

- ☞ When there is a need of two SLA batteries, make sure to use two batteries with the same battery capacity in Ah. For example, both batteries must be 12V/7A or 12V/4A SLA battery pack; instead, one 12V/7A and one 12V/4A is not allowed.
- To install the battery, follow the steps below:

It is recommended to use fused battery cable.

 - 1) Connect the GND cable (Black) to the Negative terminal (-) on the Panel.
 - 2) Connect the power cable (Red) to the Positive terminal (+) on the Panel.
 - 3) Connect the GND cable (Black) to the negative pole (-) of battery.
 - 4) Connect the power cable (Red) to the positive pole (+) of battery
 - 5) Use the double-sided adhesive pad to fix the backup battery to the Control Panel.

Using the built-in Power Unit

- **AC Module** built-in Power Unit or **Open Frame** built-in Power Unit is installed. For AC module, connect 2 wires of the AC Transformer to 2 terminals of the built-in Power Unit. For Open Frame, connect **BROWN** wire of the power cord to Terminal **L** of the built-in Power Unit, and connect **BLUE** wire to Terminal **N**. Please refer to two figures below.

Note:

☞ Ensure to turn off all power supplies including Built-in Power Unit and SLA Battery before connecting or removing cables or wires.

- **AC Module built-in Power Unit:**

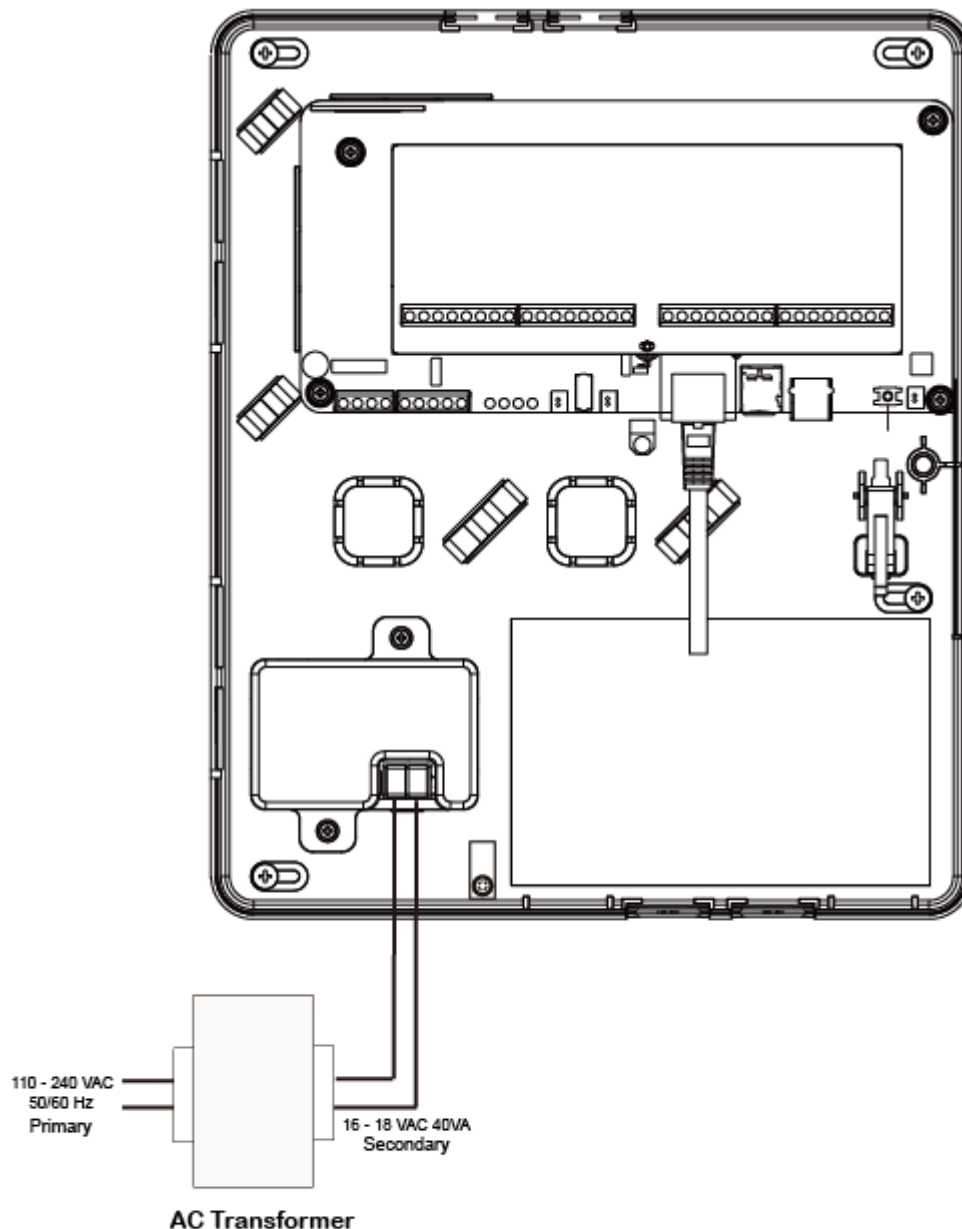

AC Module Built-in Power Unit:
Connecting 2 wires of AC Transformer to
2 terminals of the Built-in Power Unit

- **Open Frame built-in Power Unit:**

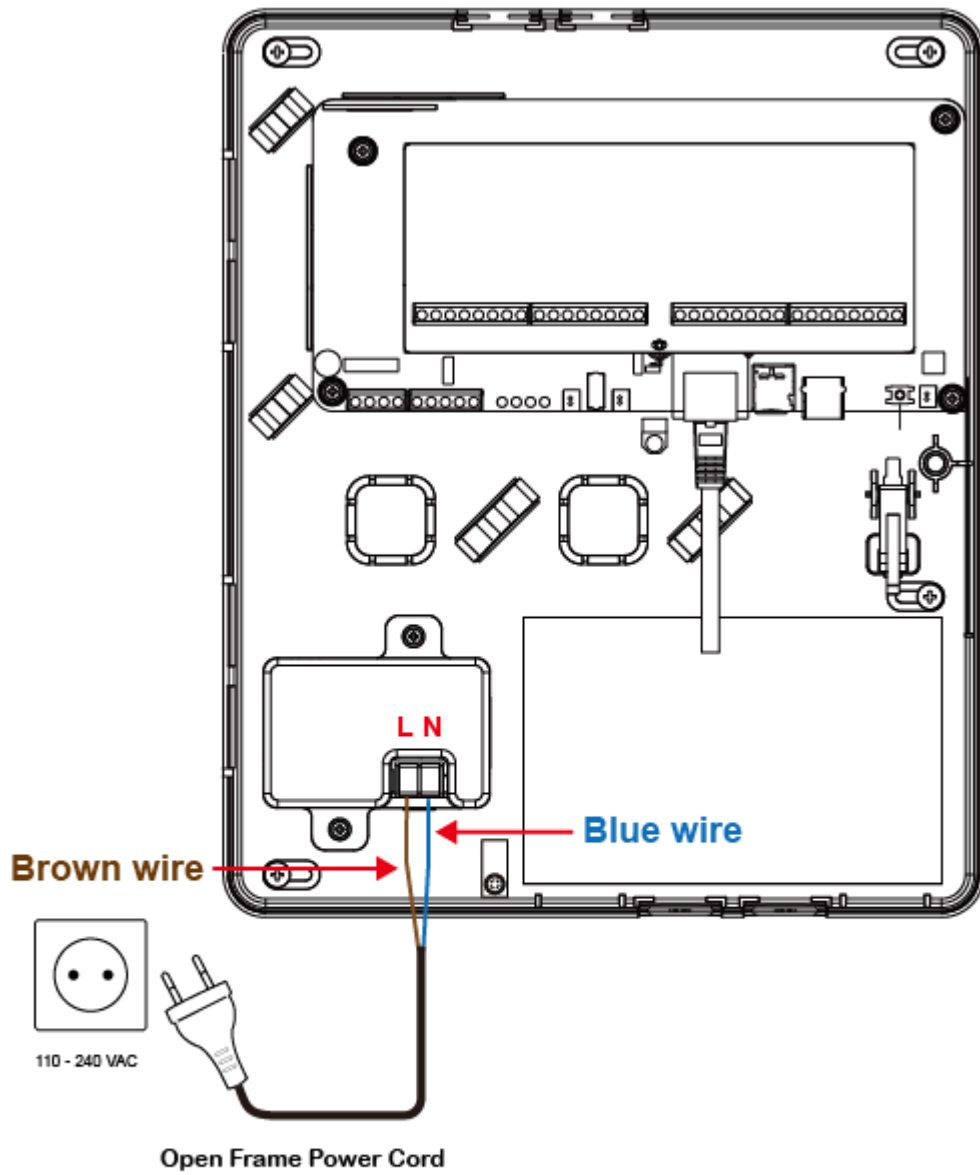

Open Frame Built-in Power Unit:
Connecting *BROWN* wire to Terminal *L*
Connecting *BLUE* wire to Terminal *N*

Caution:

- Wiring of the Hybrid Alarm System should only be performed by certified technician with proper knowledge and training in electric equipment.
- Before installation or any maintenance work, make sure the power supply has been disconnected.
- Do not connect the devices to loads exceeding supported load current.
- Do not connect the battery or the built-in power unit until all wiring is complete.
- The control panel enclosure must be secured to the wall before operation.
- Internal wiring must be routed in a manner that **prevents**:
 - Wiring over circuit boards
 - Excessive strain on wire and on terminal connections
 - Loosening of terminal connections
 - Damage of conductor insulation
- Incorrect connections will result in failure or improper operation. Inspect wiring and ensure proper connections before applying power.
- **Ensure to turn off all power supplies including Built-in Power Unit and SLA Battery before connecting or removing cables or wires.**

3.4. Software Installation

※ THIS INSTALLATION IS ONLY REQUIRED FOR FIRST TIME USER ※

1. RUNNING THE FINDER SOFTWARE

The Finder software is required for your computer to identify the control panel on the LAN.

Step 1. To download Finder software, open your browser and type below URL in the address bar: <http://www.climax.com.tw/climax-download-finder.html>.

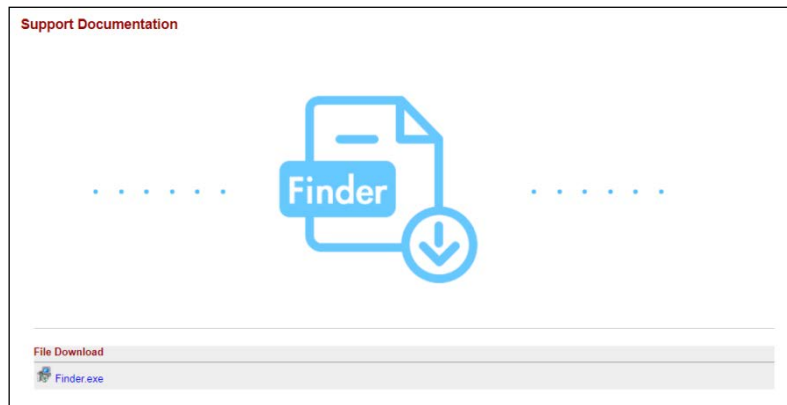

Step 2. After download, install the software and follow on-screen instructions to complete installation.

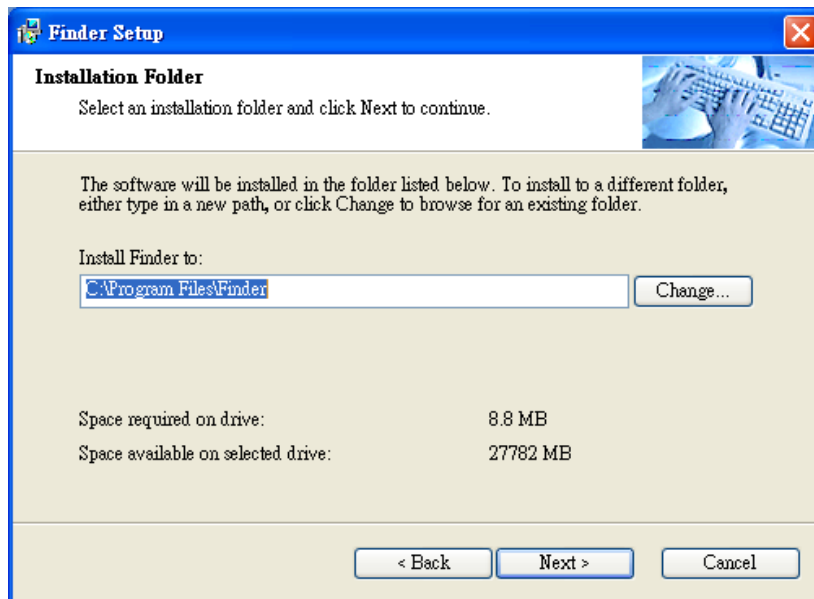

Step 3. Follow on screen instruction to complete installation.

Step 4. Once complete, the Finder icon will be displayed on your desktop.



Step 5. Execute the Finder software. Finder will automatically search for control panel on the LAN and display its information. If available, the panel's LAN IP address, Firmware version and MAC address will be displayed

4. Connection to Panel Webpage

For first time setup, webpage connection is only available within 1 hour after the panel is powered on; if the panel has been powered on for more than 1 hour. Webpage access will be disabled. Reboot the panel to enable webpage function again.

Step 1. Select the Control Panel in the Finder software and click on “Open Webpage” to connect to panel webpage.

Alternatively, enter the Control Panel IP address displayed in Finder into your browser’s address section and proceed.

Step 2. Enter the User name & Password to proceed

User name: **admin**

Password: **cX+HsA*7F1**

(If wrong user name and password are entered for 5 times, the local webpage login will be disabled for 5 minutes.)

Step 3. You will enter panel Welcome page. The Control Panel’s information will be displayed. Click on the pages and folders on the left to access the Control Panel’s various functions

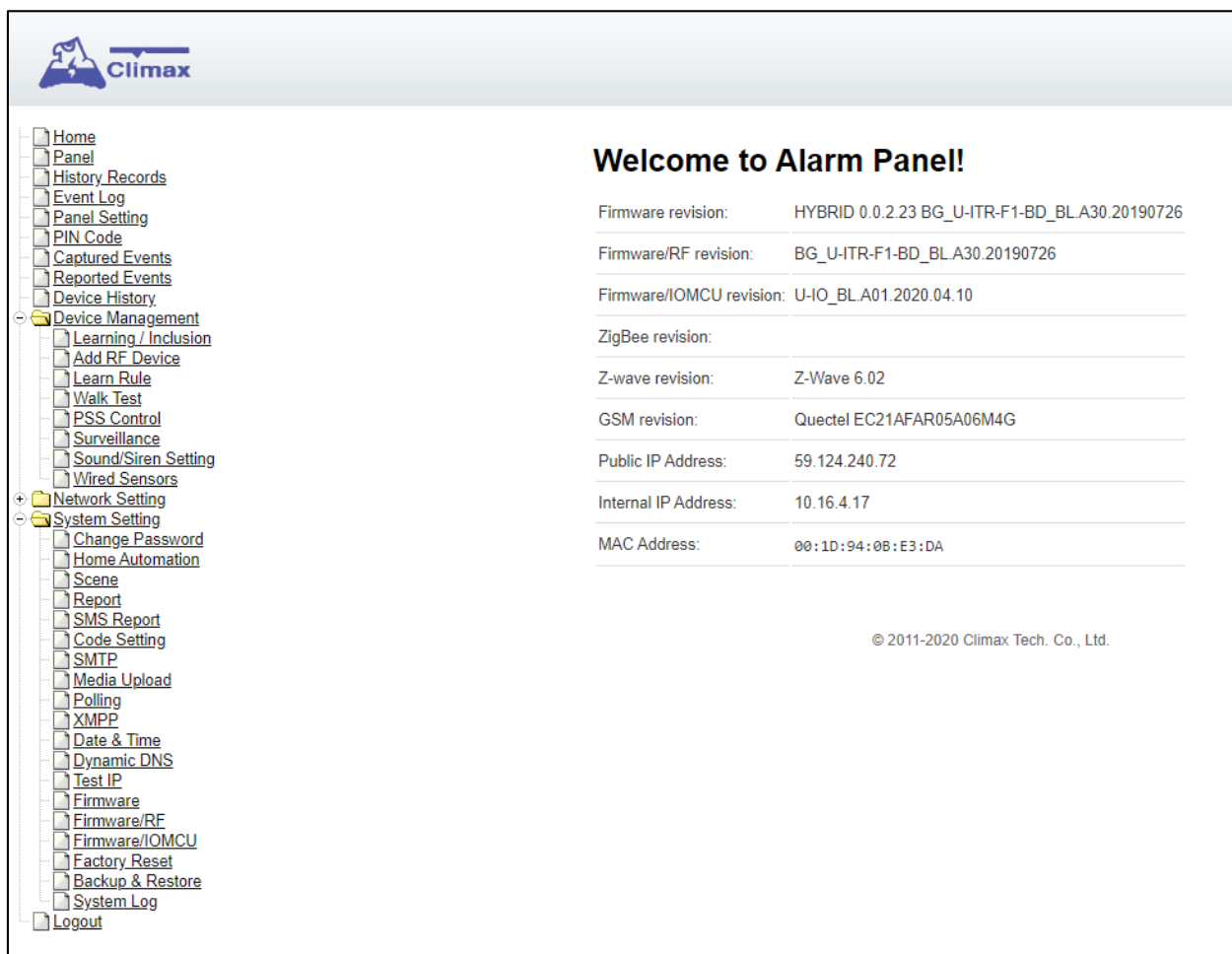

The screenshot shows the Climax Alarm Panel Webpage. On the left is a sidebar menu with the following items: Home, Panel, History Records, Event Log, Panel Setting, PIN Code, Captured Events, Reported Events, Device History, Device Management (expanded), Learning / Inclusion, Add RF Device, Learn Rule, Walk Test, PSS Control, Surveillance, Sound/Siren Setting, Wired Sensors, Network Setting (expanded), System Setting (expanded), Change Password, Home Automation, Scene, Report, SMS Report, Code Setting, SMTP, Media Upload, Polling, XMPP, Date & Time, Dynamic DNS, Test IP, Firmware, Firmware/RF, Firmware/IOMCU, Factory Reset, Backup & Restore, System Log, and Logout. The main content area displays 'Welcome to Alarm Panel!' followed by a table of system information:

Firmware revision:	HYBRID 0.0.2.23 BG_U-ITR-F1-BD_BL.A30.20190726
Firmware/RF revision:	BG_U-ITR-F1-BD_BL.A30.20190726
Firmware/IOMCU revision:	U-IO_BL.A01.2020.04.10
ZigBee revision:	
Z-wave revision:	Z-Wave 6.02
GSM revision:	Quectel EC21AFAR05A06M4G
Public IP Address:	59.124.240.72
Internal IP Address:	10.16.4.17
MAC Address:	00:1D:94:0B:E3:DA

At the bottom right of the page, there is a copyright notice: © 2011-2020 Climax Tech. Co., Ltd.

The Welcome page displays current control panel firmware version information according to different panel model and MAC address.

5. Device Management

The Device Management section allows you to learn in, edit, control and view all available accessory devices that can be included in the Panel.

5.1. Learning of Devices

Use this function to add new devices into the Control Panel. Hybrid Security Alarm System supports up to a total of 160 zones of accessory devices, in 2 areas, up to 80 zones each area.

The following types of accessory devices are supported:

- **RF device:** All Climax RF devices are supported.
- **IP Cameras:** The Control Panel is compatible with Climax VST-1818 Series IP Camera. Up to 6 IP Cameras are supported.

5.1.1. Add Sensor

Step 1. Click on “**Learning**” to enter learn page.

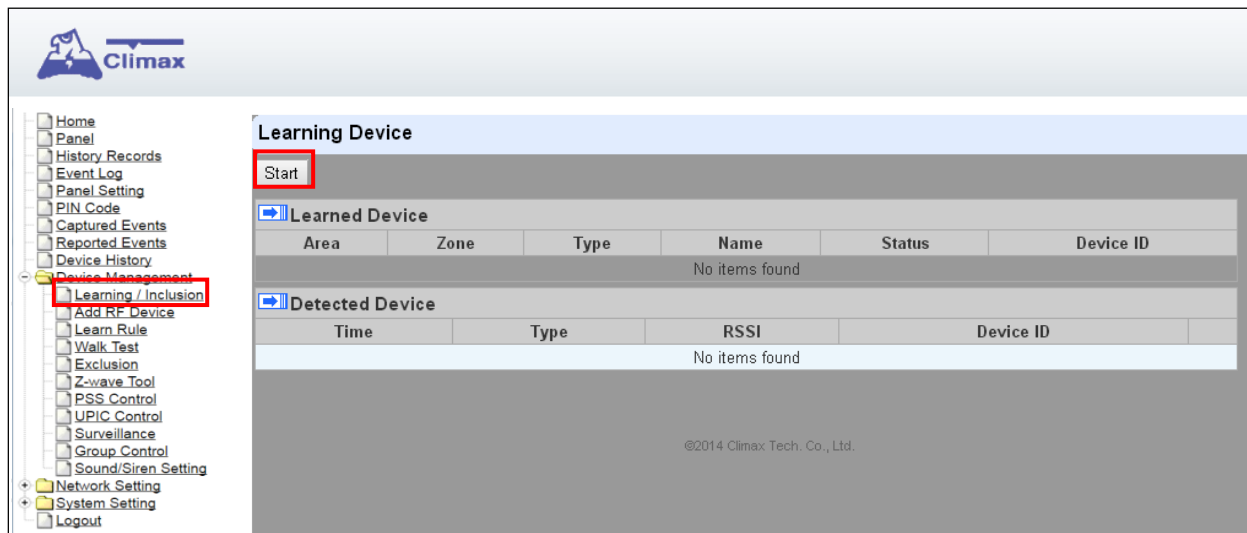

Step 2. Click on “**Start**” to enter learning mode.

Step 3. Press the test or learn button on the each device or any button on the Remote Controller. (Please refer to each sensor’s user manual for test or learn button position).

Step 4. Click “**Add**” to include selected device into panel. If the sensor you wish to learn into already exists in the system, the sensor information will be displayed in the **Learned Device** section. If not, the sensor information will be displayed in the **Detected Device** section.

<NOTE>

- For VST-862 F1 devices, press and hold the learn button for 3 seconds for the Control Panel to receive a learn code, and then click “**Add**” within 30 seconds.

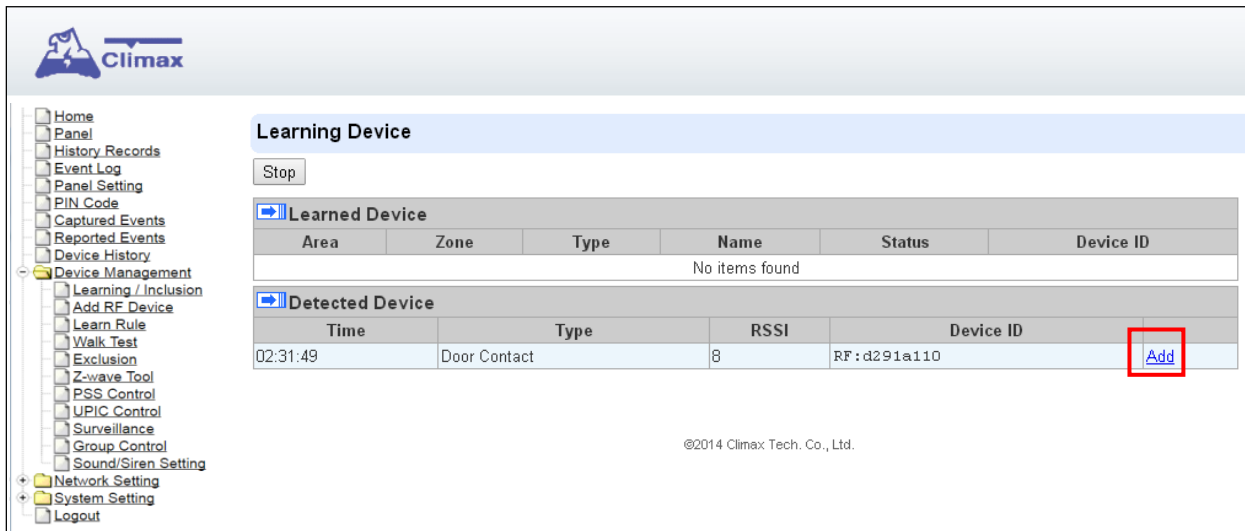

Step 6. If the device is successfully learnt into the system, the added device will be displayed in the “**Learned Device**” section.

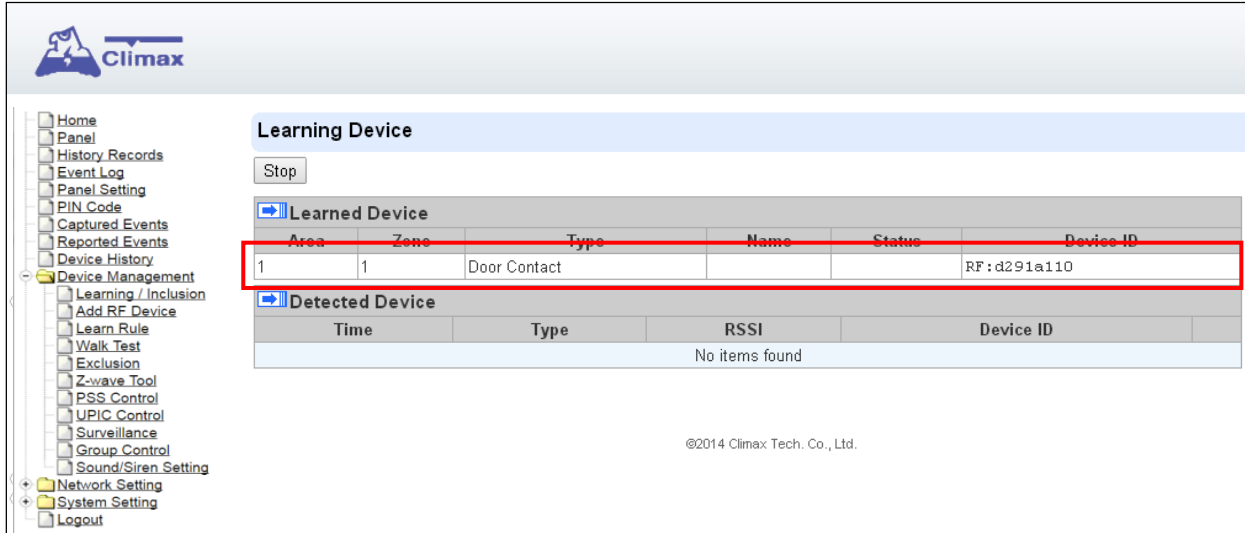

Step 7. Repeat Step 3~5 to learn in all device, click Stop to exit learn mode when complete. The system will automatically exit Learn mode if left idle for 5 minutes.

5.1.2. Local Learning

Instead of learning devices via configuration webpage, you can also learn in devices by using the learn button of the Control Panel.

- Step 1.** Press and hold the learn button of the Control Panel for 10 seconds, release when the Control Panel emits one short beep. LED 1 & 2 (Green) will turn ON to indicate the Control Panel is now in learning mode.
- Step 2.** Press the test or learn button on each device to transmit signal, refer to device manual for detail.
- Step 3.** When the Control Panel receives signal from device, it will emit 2 beeps to confirm. The device will be included in the panel automatically.
- Step 4.** After finishing learning all devices, press the button once. The Control Panel will emit 2 short beeps to indicate it has returned to normal operation mode. LED 1 & 2 will dim. If the user does not press the button within 5-6 minutes, the system will automatically return to normal operation mode.

<NOTE>

- The Control Panel cannot enter learning mode when under Away Arm/Home Arm or Walk Test mode. The Control Panel will emit 5 beeps to indicate error.

5.1.3. Edit Devices

After finish learning devices, proceed to edit the device setting.

Step 1. Click **Panel** to enter Panel webpage. All learnt in devices will be displayed under **Device List** section.

Panel Control

Area 1
Current mode: Disarm
 Disarm Full Arm Home Arm 1 Home Arm 2 Home Arm 3

Area 2
Current mode: Disarm
 Disarm Full Arm Home Arm 1 Home Arm 2 Home Arm 3

Panel Status

Battery	Tamper	Interference	AC activation	Signal GSM	Background RSSI
Normal	N/A	Normal	Normal	N/A	0

Test System:

System in maintenance

Fault Status

Fault	Setting
SIM Not Inserted	<input type="checkbox"/> Clear
GSM No Signal	<input type="checkbox"/> Clear

Reload

Device List

Area	Zone	Type	Name	Condition	Battery	Tamper	Bypass	RSSI	Status
1	1	Door Contact		Normal	Normal	Normal	No	N/A	Edit Delete

Note

No.	Type	Description
#1		Edit
#2		Edit
#3		Edit
#4		Edit
#5		Edit

Step 2. To edit the device setting or information, click **“Edit”** at end of device entry.

Area	Zone	Type	Name	Condition	Battery	Tamper	Bypass	RSSI	Status
1	1	Door Contact		Normal	Normal	Normal	No	N/A	Edit Delete

Step 3. You will enter Device Edit webpage



- Home
- Panel
- History Records
- Event Log
- Panel Setting
- PIN Code
- Captured Events
- Reported Events
- Device History
- + Device Management
- + Network Setting
- + System Setting
- Logout

Device Edit

Door Contact

ID: RF:03d6b110

Version: _____

Capability: _____

Name:

Area:

Zone:

Attribute: Permanently Bypass

Attribute: Latch report

Attribute: Set/Unset:

Attribute: 24 HR:

Disarm Response:

Full Arm Response:

Home Arm 1 Response:

Home Arm 2 Response:

Home Arm 3 Response:

Trigger Response:

Restore Response:

Exit: No Response

Or [Cancel](#)

Step 4. Edit your device setting and information according to instruction below. Click “OK” to save your new changes when finished. Alternatively, click “Default” to reset all parameters to default values or click “Reset” to re-enter all the information.

- **Name:** Enter a name for the device.
- **Area:** Select the area which the device belongs to.
- **Zone:** Select the Device zone number.

- **Attribute List:**
The attribute list determines panel behaviour when the panel receives trigger signal from the device. There are

General Attribute:

☞ [Permanently Bypass](#)

This function allows user to permanently deactivate (bypass) the selected device.

- If bypassed, then the Control Panel will not respond at all when the sensor is triggered.
- If bypassed, the system can be armed directly regardless the device’s fault situation. However, its fault situation will still be monitored, logged and displayed in the webpage.

☞ [Latch report](#)

This function **ONLY** applies to Remote Control or Door Contact with Set/Unset attribute enabled.

- Latch Report **ON**: When the device is used to change system arm mode, the Control Panel will report the arm/disarm action by the particular device.
- Latch Report **OFF**: When the device is used to change system arm mode, the Control Panel will not report the arm/disarm action by the particular device.

Set/Unset

This function is for Door Contact only. This function allows Door Contact to control system mode.

- **Normal Close**: The system will be armed when the Door Contact is opened, and disarmed when Door Contact is closed.
- **Normal Open**: The system will be armed when the Door Contact is closed, and disarmed when Door Contact is open.

24HR

This function enables the device to activated selected alarm event whenever it is triggered regardless of system mode. System mode response will be disabled if 24HR attribute is enabled.

System Mode Attributes:

The System Mode Attributes determines system behavior under particular arming mode when the sensor is triggered.

No Response

- When a sensor with **No Response** is triggered, the Control Panel will not respond.

Start Entry Delay 1/ Start Entry Delay 2

- When the system is under Full Arm or Home Arm mode, if a sensor with **Start Entry Delay 1/2** attribute is triggered, Control Panel will start an entry countdown period to give enough time to disarm the system.
- When the Control Panel is in the Disarm mode, if a sensor with **Start Entry Delay 1/2** attribute is triggered, the Control Panel will immediately report a burglar interior alarm (**CID code: 132**).
- When the Control Panel is in the Full Arm mode, if a sensor with **Start Entry Delay 1/2** attribute is triggered, the Entry Delay 1/2 timer starts counting down. If no correct pin code is entered during the entry delay timer to disarm the system, the Control Panel will report a burglar perimeter alarm (**CID code:131**) immediately after entry delay timer 1/2 expires.
- When the Control Panel is in the Home Arm 1/2/3 mode, if a sensor with **Start Entry Delay 1/2** attribute is triggered, the Entry Delay 1/2 timer starts counting down. If no correct pin code is entered during the entry delay period to disarm the system, the Control Panel will report a burglar interior alarm (**CID code: 132**) immediately after entry delay timer 1/2 expires.

Chime

- When the system is in Arm/ Home Arm 1/ Home Arm 2/ Home Arm 3 mode, if a sensor set to Chime is triggered, the Control Panel will sound a Door Chime (Ding-Dong Sound).

Burglar Follow

- When the system is in Full Arm or Home Arm mode mode, if a sensor set to **Burglar Follow** is triggered, the Control Panel will report a burglar alarm immediately.
- When a Start Entry sensor is triggered and the system is under Entry Delay Timer countdown, if a sensor set to **Burglar Follow** is triggered, the Control Panel will wait until the Entry Delay Timer expires before activating a burglar alarm. If the system is disarmed before the timer expires, the Control Panel will not activate alarm.

☞ **Burglar Instant**

- When the system is under Full arm or Home Arm / Disarm / Entry Time mode, if a sensor set to **Burglar Instant** is triggered, the Control Panel will report a burglar alarm immediately.

☞ **Burglar Outdoor**

- When the system is in Full Arm or Home Arm / Disarm / Entry Time mode, if a sensor set to **Burglar Outdoor** is triggered, the Control Panel will report a burglar outdoor event immediately.

☞ **Cross Zone**

- See **10.3 Appendix – Cross Zone Verification** for detail.

☞ **Apply Scene**

- This function is only available for Remote Keypad and Remote Control.
- Select a Home Automation Scene number for a Remote Keypad or Remote Control button. When the button is pressed, the Control Panel will execute the actions programming in the Scene accordingly. For more information, please refer to **8.3. Scene**.

Home Automation Attributes:

The Home Automation Attributes allows a device to control Home Automation function.

☞ **Trigger Response**

- When the device is triggered, the Control Panel will activated selected Home Automation Scene number. Please refer to **8.3. Scene** webpage for detail.

☞ **Restore Response**

- When the device transmits restore signal after trigger, the Control Panel will activate selected Home Automation Scene number.

Other Attributes:

☞ **Permanent Bypass**

- When checked, the panel will completely ignore all signal received from this device. A bypassed device will be unable to trigger any response, including alarm or fault from the Control Panel. All other attribute settings will be also be ignored.

☞ **Exit (No Response)**

- If checked, the panel will ignore trigger signal from this sensor during Exit Time countdown. If deselected, the panel will activated burglar alarm and report immediately when the sensor triggered during Exit Delay Timer.

☞ **24HR**

- A sensor set to 24HR attribute will ignore Disarm, Full Arm, Home are and Exit response setting. The panel will activate selected alarm when this sensor is triggered regardless of system mode under any time.

<NOTE>

- Some devices have their own unique functions and will have its own attribute setting which is not listed in this section. Please refer to the device manual for its setting detail.

5.1.4. Delete Devices

Step 1. To delete a sensor, click “Delete” under “Device List”

Device List										
Area	Zone	Type	Name	Condition	Battery	Tamper	Bypass	RSSI	Status	
1	1	Door Contact		█	█	█	No	N/A		Ed Delete

Step 2. A message “Delete success” is displayed and the sensor you choose is deleted successfully.

5.1.5 Learning of Expansion Boards (WEZC-8)

Step 1. Connect the expansion board to the Control Panel. Then, power on the Control Panel.

Step 2. Click on “Learning” to enter learn page.

The screenshot shows the Climax web interface. On the left sidebar, the 'Learning / Inclusion' option is highlighted with a red box. The main content area is titled 'Learning Device' and contains a 'Start' button, also highlighted with a red box. Below the 'Start' button, there are two tables: 'Learned Device' and 'Detected Device'. Both tables currently show 'No items found'. The 'Detected Device' table has columns for Time, Type, RSSI, and Device ID.

Step 3. Click on “Start” to enter learning mode.

The screenshot shows the Climax web interface after clicking 'Start'. The 'Learning Device' page now has a 'Stop' button at the top. The 'Learned Device' table is empty. The 'Detected Device' table now contains one entry:

Time	Type	RSSI	Device ID
02:29:28	Expander		IN:0020bb00

 The 'Add' button at the end of this row is highlighted with a red box.

Step 4. Click “Add” to include expansion board into panel.

Step 5. If expansion board is successfully learnt into the system, the added device will be displayed in the “Learned Device” section.

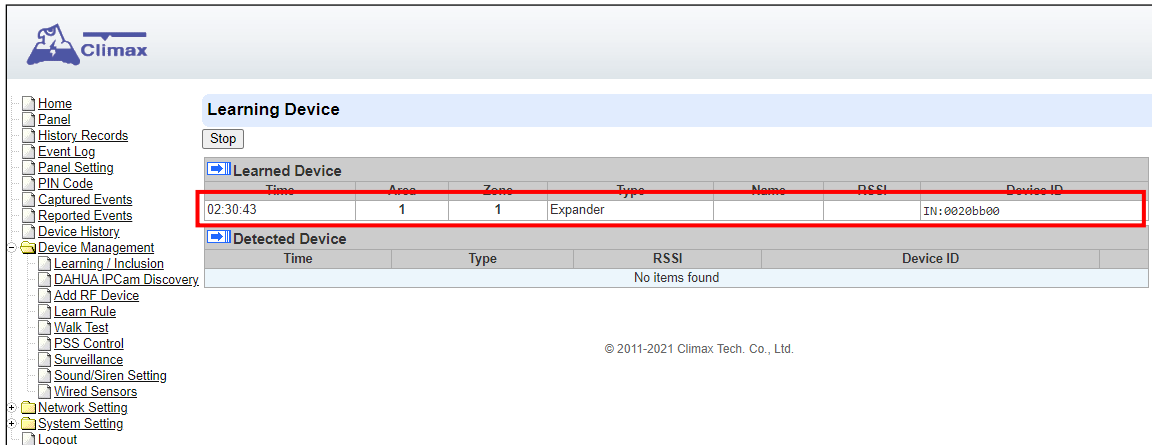

<NOTE>

- For details on how to program wired zones, please refer to **5.12. Wired Zones Programming.**

5.2. Add RF Device

Besides learning, you can also add RF devices into the system by entering its RF code into the system with **Add RF Device** function.

Step 1. Click **Add RF Device**.

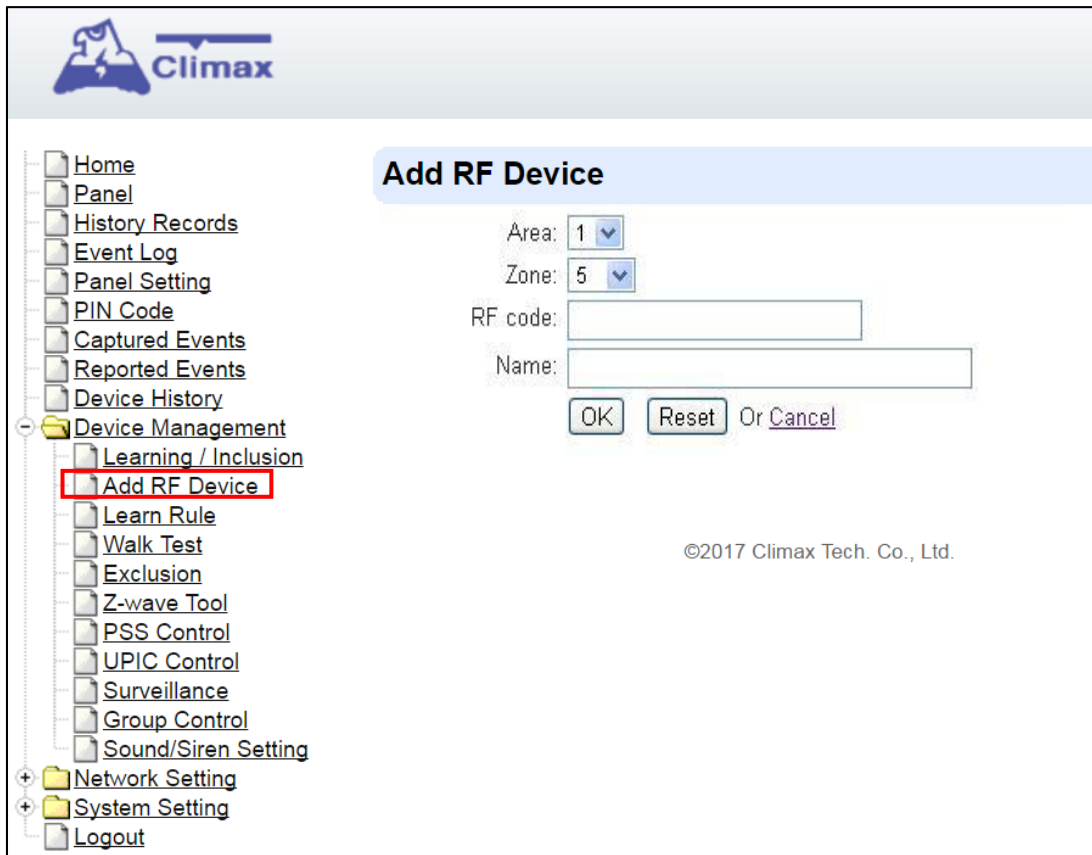

Step 2. Select Area and Zone number for the device you wish to add into system.

Step 3. Enter the device RF code, and preferred device name (up to 31 characters)

Step 4. Press “OK” to save

Step 5. If the RF code you entered is valid, the device will be added into the system according to the Area and Zone number. You do not need to learn the device as instructed in **5.1.1. Add Sensor.**

5.3. Learn Rule

You can enter the sensor RF code MAC address manually to assign area and zone number to this sensor. Sensors learned with pre-assigned rule will be put under the area and zone number you specified. This function does not work with Shutter Control devices.

Step 1. Click **Learn Rule.**

The screenshot displays the Climax web interface. On the left is a navigation tree with 'Device Management' expanded to show 'Learn Rule'. The main content area is titled 'Device Learn Rule' and contains a table with the following structure:

Area	Zone	Type	Name
No items found			

Below the table are two links: [Add Learn Rule...](#) and [Backup Device List to Learn Rule](#). The footer of the page reads '©2014 Climax Tech. Co., Ltd.'

Step 2. You will see the **Add Learn Rule** menu.

Add Learn Rule

Area: ▼

Zone: ▼

System: RF ZigBee

RF code:

ZigBee MAC:

ZigBee Device Type: ▼

Name:

Or [Cancel](#)

Step 3. Select **Area** and **Zone** number for this device.

Step 4. Select **RF**.

Step 5. Key in the RF code info

Step 6. Enter a preferred name for sensor (up to 31 letters or numbers).

Step 7. Press “OK” to save.

Step 8. If the process is successful, the screen will display “**Updated Successfully.**” You can then check, edit or delete the rule under the **Learn Rule** menu.

Step 9 Repeat the steps to add more rules.

Step 10. Learn in the sensors you have entered rules for according to **5.1.1 Add Sensor**.

<NOTE>

- Learn rule function is only used to pre-assign area and zone number to sensors before learning. To add sensor to control panel, you still need to follow the instruction in **5.1.1 Add Sensor** to complete the learning process.
- **Backup Device List to Learn Rule**

5.4. Walk Test

This is to test the sensor operation range for installation purpose.

Step 1. Click “**Start**” to enter Walk Test mode.



Step 2. Press the test button on the sensor(s) or any button on the Remote Controller or triggering the sensor.

Step 3. When the Control Panel receives a signal, it will show as below and a 2-tone beep will be heard to indicate that it is safe to install the particular sensor in the location.

- **Time:** time information
- **Area:** operation area
- **Zone:** device zone
- **Type:** device type
- **Name:** device name
- **RSSI:** the RF signal strength between Control Panel and sensor. The RSSI value here must be higher than the RSSI value of Panel's background noise (please refer to **6.1 Panel Condition** section for details). If not, you may still learn in the sensor; however, please relocate the sensor and use Walk test to find a more suitable location.
- **DeviceID:** device's unique identification code.

Step 4. Once all sensors are tested, click on “**Stop**” to exit Walk Test mode. The system will automatically exit Walk Test mode if left idle for 5 minutes.

5.5. Exclusion

This feature is only available for Shutter Control modules only, or when a Shutter Control dongle is inserted into the Control Panel. This feature is for you to remove Shutter Control device only.

Step 1. Click on “**Exclusion**” and click on “**Start**” to start the procedure. Then the Panel will enter the removing mode.

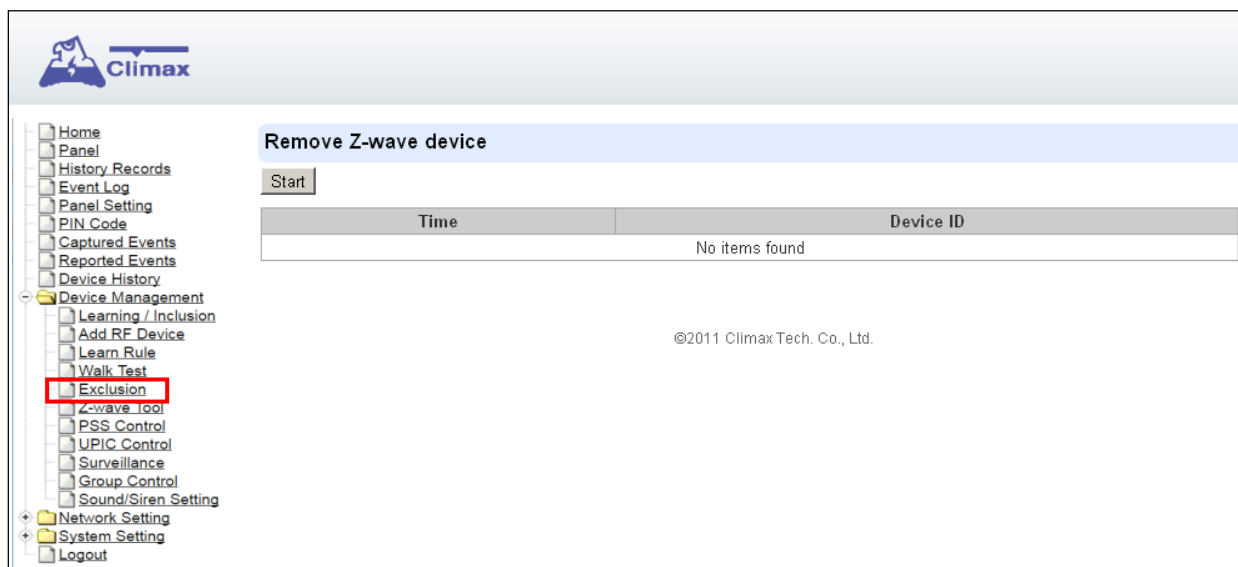

Step 2. Refer to the Shutter Control device manual to transmit signal.

Step 3. Select the desired Shutter Control and click **delete** to remove it from the Shutter Control list under **Device List** section (**Panel**). Then the Control Panel will remove the Shutter Control device.

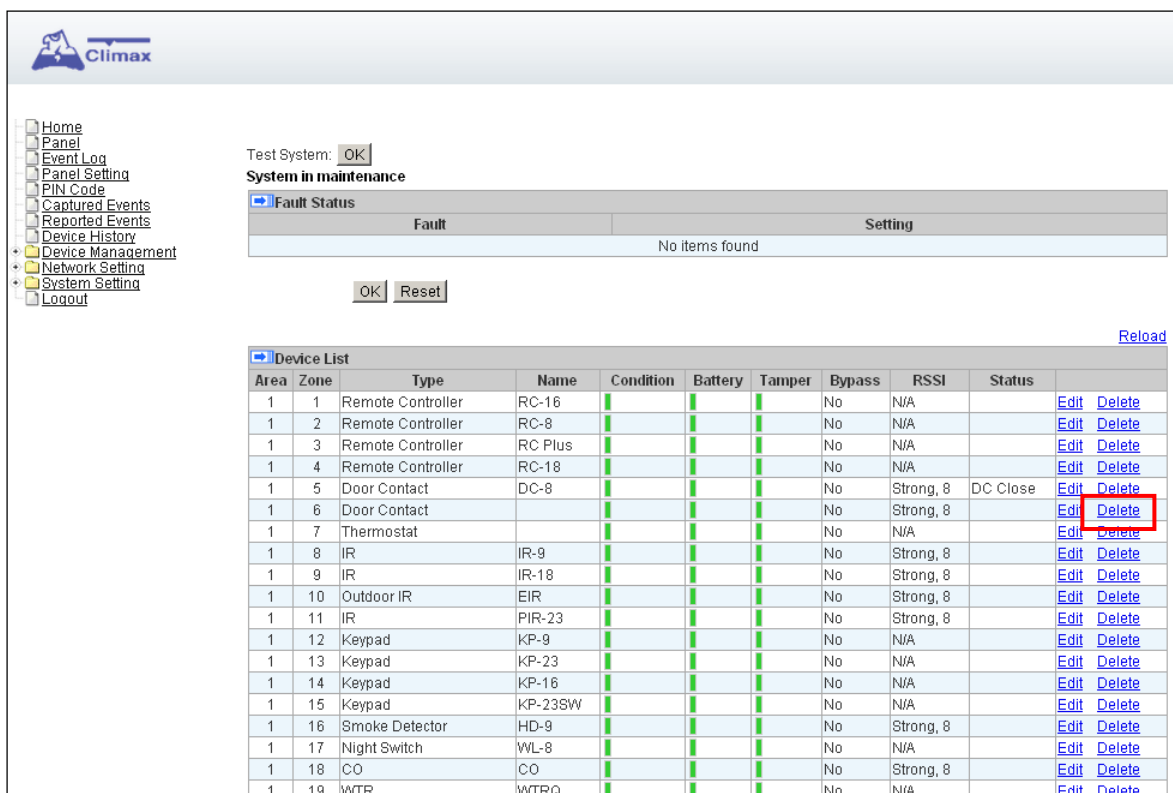

5.6. Shutter Control Tool

The Shutter Control Tool is used to reset Shutter Control module to factory default and remove all Shutter Control devices, or change routing setting.

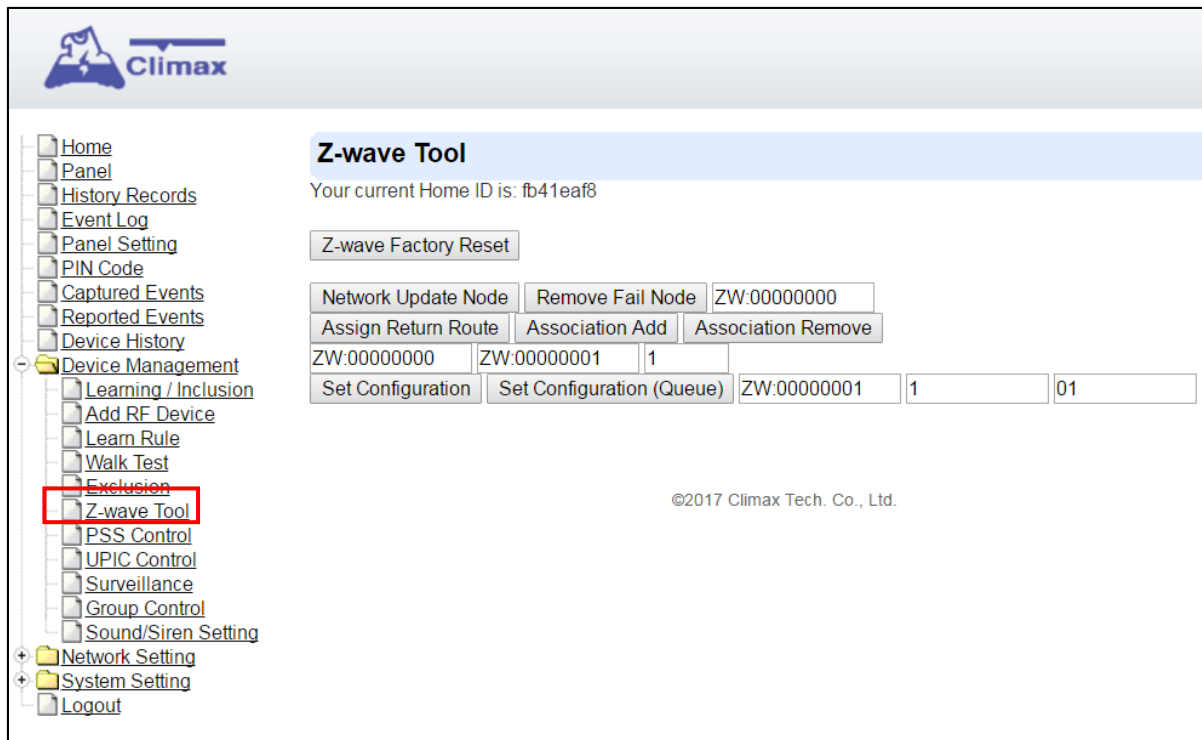

Step 1. Click "Shutter Control Factory Reset", the Shutter Control module is reset to factory default and all Shutter Control devices will be removed automatically. The Control Panel Home ID will also be changed automatically for a newly added Shutter Control device to recognize.

Step 2. The list of Shutter Control devices is still displayed in the **Panel** webpage. Please go to panel webpage and remove all Shutter Control devices.

- **Change Shutter Control Routing Setting**

Use the other functions to configure your Shutter Control routing settings.

5.7. PSS Control

This feature is designed to control/edit/delete Power Switches included in the panel.



The screenshot displays the Climax web interface. On the left is a navigation menu with items like Home, Panel, History Records, Event Log, Panel Setting, PIN Code, Captured Events, Reported Events, Device History, Device Management (expanded), Learning / Inclusion, Add RF Device, Learn Rule, Walk Test, Exclusion, Zwave Tool, **PSS Control** (highlighted with a red box), UPRC Control, Surveillance, Group Control, Sound/Siren Setting, Network Setting, System Setting, and Logout. The main content area is titled 'Power Switch Sensor' and contains a table with the following data:

Area	Zone	Type	Name	Status	
1	1	Power Switch Meter		Off, 0.0W	Edit Delete Switch On Switch Off Switch Toggle

Below the table, the text '©2011 Climax Tech. Co., Ltd.' is visible.

- Click **Edit** to edit attributes of power switches.
- Click **Delete** to remove power switch from panel.
- Click **Switch On/Switch Off** to turn on/off power switches. Or click **Switch Toggle** to toggle between on/off status. For Power Switch Dimmer, you can also set its power output level with the slide down menu.

5.8. UPIC Control

UPIC Control webpage allows you to control UPIC IR Transmitter included in Control Panel.

The screenshot displays the Climax UPIC Control interface. On the left is a navigation tree with 'UPIC Control' selected. The main panel shows a table with the following data:

Area	Zone	Type	Name
1	1	UPIC	Off

Below the table, there are dropdown menus for 'Air Conditioner', 'TV', 'Home Audio', 'Set-top Box', and 'Others', each with a 'Setup UPIC' button. A diagram titled 'UPIC5 LEDs' shows a central blue circle connected to five surrounding blue circles numbered 1 through 5.

- **Transmit IR Signal**

Depending on the UPIC model number, select the function to be performed in the drop down menu, then click “Setup UPIC” for the UPIC to transmit IR Signal.

- **UPIC5 LED Setup (UPIC5 only)**

UPIC5 has 6 IR LEDs, a central one and 5 surrounding ones. The central LED will always transmit IR signal when activated; besides the central LED, one of the 5 surrounding LEDs can be selected to activate upon IR signal transmission to increase the IR signal coverage.

Step 1: Refer to the diagram on the webpage and UPIC5 manual to determine which LED should be used for signal transmission to each particular home appliance.

Step 2: Select the LED number from the drop down menu for each appliance type, then click “Setup LED” to confirm. Please refer to UPIC5 manual for more information.

<EXAMPLE>

- If “Air Conditioner” is set to LED 1, UPIC5 will transmit all Air Condition functions with both Central LED and LED1.
- If “TV” is set to LED 5, UPIC5 will transmit all Air Condition functions with both Central LED and LED5.

5.9. Surveillance

The PIR Camera/Video Cameras and IP Cameras are listed under **Surveillance** for separate control.



Surveillance

Area	Zone	Type	Name	
1	2	IR Camera		Edit Delete Request Media Request Media (No Flash)
1	9	IP Camera		Edit Delete Request Media View Setting

©2015 Climax Tech. Co., Ltd.

- Click **Edit** to edit camera attributes.
- Click **Delete** to remove device from panel.
- Click **Request Media** to capture a picture or video
 - PIR camera: A picture will be captured upon request
 - PIR Video Camera: A 10-second video will be recorded upon request
 - IP Camera: The IP Camera will record a video according to its video length setting (Please refer to IP Camera manual for detail.)
 - For PIR Camera/Video Camera, you can choose to take the picture/video without activating the camera's flash.

Picture and video captured by PIR Camera and PIR Video Camera will be stored under the **Captured Event** webpage. Video Recorded by IP Camera will be stored in the IP Camera, please refer to IP Camera manual to view the video

- For IP Camera, click "View" or "Setting" to access IP Camera webpage for video streaming or setting configuration. A new webpage will open and you will be required to enter the username and password for the IP Camera to access streaming or setting.

5.10. Group Control

This feature is designed for you to edit a name of group, switch on or off a group of Power Switches. You can also assign Power Switches to groups you desire.

5.10.1. Group Control/Edit

Step 1. Specify a new name for a group.

The screenshot shows the Climax web interface. On the left is a navigation menu with 'Group Control' highlighted. The main area is divided into two sections: 'Group List' and 'Device List'.

Group List Table:

Group	Name	Switch On	Switch Off
1	<input type="text"/>	Switch On	Switch Off
2	<input type="text"/>	Switch On	Switch Off
3	<input type="text"/>	Switch On	Switch Off
4	<input type="text"/>	Switch On	Switch Off
5	<input type="text"/>	Switch On	Switch Off
6	<input type="text"/>	Switch On	Switch Off
7	<input type="text"/>	Switch On	Switch Off
8	<input type="text"/>	Switch On	Switch Off

Buttons:

Device List Table:

Area	Zone	Type	Name	Group 1	Group 2	Group 3	Group 4	Group 5	Group 6	Group 7	Group 8	
1	4	Power Switch Meter		<input type="checkbox"/>	<input type="checkbox"/>	<input type="checkbox"/>	<input type="checkbox"/>	<input type="checkbox"/>	<input type="checkbox"/>	<input type="checkbox"/>	<input type="checkbox"/>	Edit Delete

Buttons:

Step 2. Click Switch On or Switch Off to turn on or off one group of power switches.

5.10.2 Device Edit/Delete

Step 1. Check on the groups you wish to assign the Power Switch. This is a multiple-choice field and you can assign one Power Switch to multiple groups. Whenever one of the assigned groups receives request to turn on/off, all Power Switches belonging to the group will be activated accordingly.

The screenshot shows a close-up of the Device List table. The first row shows a device in Area 1, Zone 1, Type Power Switch Meter, Name (empty), and checked in Group 1.

Device List Table:

Area	Zone	Type	Name	Group 1	Group 2	Group 3	Group 4	Group 5	Group 6	Group 7	Group 8	
1	1	Power Switch Meter		<input checked="" type="checkbox"/>	<input type="checkbox"/>	<input type="checkbox"/>	<input type="checkbox"/>	<input type="checkbox"/>	<input type="checkbox"/>	<input type="checkbox"/>	<input type="checkbox"/>	Edit Delete

Buttons:

Step 2. Click **Edit** to edit attributes of an added power switch or power switch meter or **Delete** to delete this device.

5.11. Sound/Siren Setting

The Sound/Siren Setting page includes setting Siren configuration function.

Sound/Siren Setting

Area	Zone	Type	Name	
1	4	Siren		Edit Delete

RF Siren Setup

©2017 Climax Tech. Co., Ltd.

5.11.1. Device Edit/Delete

Click **Edit** to edit the Siren's attribute, volume and voice settings, or **Delete** to delete the Siren.

Sound/Siren Setting

Area	Zone	Type	Name	
1	4	Siren		Edit Delete

RF Siren Setup

After clicking **Edit**, you will be directed to the Device Edit page:

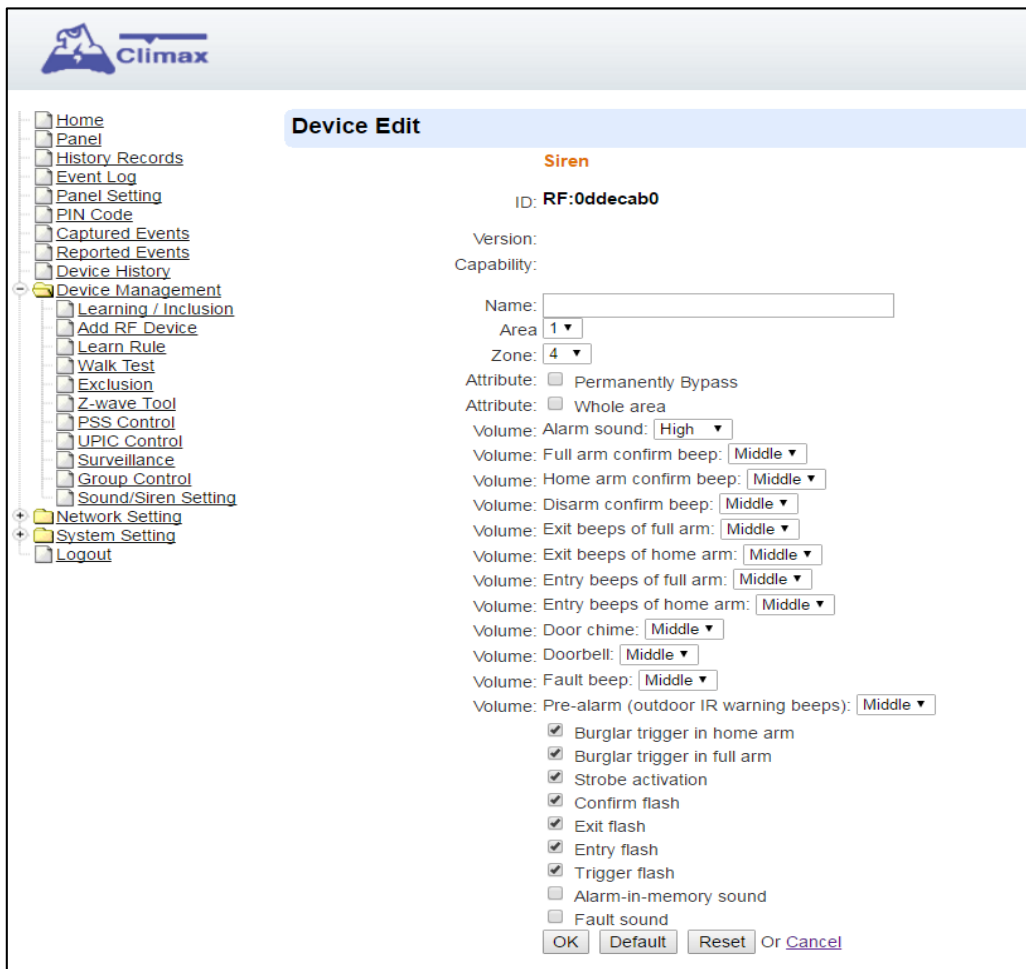

<NOTE>

- The Device Edit page is only available for the newest BX/Siren series and BX series **without DIP Switch**.

Edit your Siren setting and information accordingly to instruction below. Click “**OK**” to save your new changes when finished. Alternatively, click “**Default**” to reset all parameters to default values or click “**Reset**” to re-enter all the information.

- **Name:** Enter a name for the Siren.
- **Area:** Select the area which the Siren belongs to.
- **Zone:** Select the Siren zone number.

☞ **Attribute:**

- **Permanently Bypass:** If checked, the Control Panel will completely ignore all signal received from the Siren. A bypassed Siren will not be able to trigger any response, including alarm or fault from the Control Panel. All other attribute settings will also be ignored.
- **Whole Area:** if checked, all the Volume, Voice and Behavior functions will be simultaneously enabled in Area 1 and Area 2.

☞ **Volume:**

- **Alarm Sound:** set the volume of the alarm sound of the Siren when alarming.
- **Full arm confirm beep:** set the volume of the confirm beep sound of the Siren when Control Panel is put into Full Arm Mode.

- **Home arm confirm beep:** set the volume of the confirm beep sound of the Siren when Control Panel is put into Home Arm Mode.
- **Disarm confirm beep:** set the volume of the confirm beep sound of the Siren when Control Panel is put into Disarm Mode.
- **Exit beeps of full arm:** set exit countdown beep volume under Full Arm Mode.
- **Exit beeps of home arm:** set exit countdown beep volume under Home Arm Mode.
- **Entry beeps of full arm:** set entry countdown beep volume under Full Arm Mode.
- **Entry beeps of home arm:** set entry countdown beep volume under Home Arm Mode.
- **Door Chime:** set the volume of the Door Chime sound (Ding-Dong Sound).

☞ Voice:

*(The following functions are only available for **SRV** devices):*

- **Doorbell:** set the volume of the ring tone when pressing the button on the Video Door Phone (VDP).
- **Fault beep:** set the volume of the voice played when system is force armed under fault conditions.
- **Pre-alarm (outdoor IR warning beeps):** set the volume of the voice played when an outdoor burglar sensor(Door Contact, IR) is triggered.

☞ Behavior

*(The following functions are only available for **RF** modules):*

- **Burglar trigger in home arm:** Enable or Disable whether Siren is activated when an alarm is triggered under Home Arm.
- **Burglar trigger in full arm:** Enable or Disable whether Siren is activated when an alarm is triggered under Full Arm.
- **Strobe activation:** Enable or Disable Siren LED strobe activation.
- **Confirm flash:** Enable or Disable Siren LED flash when system Armed/Disarmed.
- **Exit flash:** Enable or Disable Siren LED flash during an exit countdown period.
- **Entry flash:** Enable or Disable Siren LED flash during an entry countdown period.
- **Trigger flash:** Enable or Disable the flashing from the Siren LED when alarming.
- **Alarm-in-memory sound:** Enable or Disable Alarm in Memory sound.
- **Fault sound:** Enable or Disable system fault sounds.

5.11.2. RF Siren Setup

The screenshot shows the Climax web interface. On the left is a navigation menu with items like Home, Panel, History Records, Event Log, Panel Setting, PIN Code, Captured Events, Reported Events, Device History, Device Management (with sub-items like Learning / Inclusion, Add RF Device, Learn Rule, Walk Test, Exclusion, Z-wave Tool, PSS Control, UPIC Control, Surveillance, Group Control, Sound/Siren Setting), Network Setting, System Setting, and Logout. The main content area is titled "Sound/Siren Setting" and contains a table with one row: Area 1, Zone 4, Type Siren, and Name. Below the table is a red-bordered box titled "RF Siren Setup" containing two buttons: "Tamper On" and "Tamper Off". The footer of the interface reads "©2017 Climax Tech. Co., Ltd."

Area	Zone	Type	Name
1	4	Siren	Edit Delete

RF Siren Setup

©2017 Climax Tech. Co., Ltd.

➤ Tamper On/Off

You can enable/disable all RF Sirens tamper protection with this function. Select to turn on or off the sirens tamper function.

<NOTE>

- When turned off, if siren tamper will be enabled again automatically after one hour if not turn on manually during the one hour period.

5.12. Wired Zones Programming

Step 1. Click on “Wired Sensors” to enter this page.

Zone	Type	Loop	Resistor	Status
1	(Disabled)	1	1K ohm	Restore
2	(Disabled)	1	1K ohm	Restore
3	(Disabled)	1	1K ohm	Restore
4	(Disabled)	1	1K ohm	Restore
5	(Disabled)	1	1K ohm	Restore
6	(Disabled)	1	1K ohm	Restore
7	(Disabled)	1	1K ohm	Restore
8	(Disabled)	1	1K ohm	Restore
9	(Disabled)	1	1K ohm	Restore
10	(Disabled)	1	1K ohm	Restore
11	(Disabled)	1	1K ohm	Restore
12	(Disabled)	1	1K ohm	Restore
13	(Disabled)	1	1K ohm	Restore
14	(Disabled)	1	1K ohm	Restore
15	(Disabled)	1	1K ohm	Restore
16	(Disabled)	1	1K ohm	Restore

Step 2. If an expander module is added, you will see **Expanders** at the bottom of the page. Click “Edit” at the end of the expander’s entry to access wire zone programming.

Area	Zone	Name	Condition	Battery	Tamper	Maximum Zones	
1	1		█	█	█ Tamper	8	Edit Delete

Step 3. Edit the type of the wired sensor, zone wiring, and the EOL resistance for each zone.

- **Type:** Select the type of the wired sensor for each zone from the drop down menu.

Wired Sensors

Zone	Type
1	Door Contact
2	Door Contact
3	CO
4	Smoke Detector
5	IR
6	Water Sensor
7	Glass Sensor
8	Heat Detector
9	(Disabled)

- **Loop:** Select the number to correspond to the zone wiring for each zone from the drop down menu. On this web page, there are wiring diagrams below for your reference.

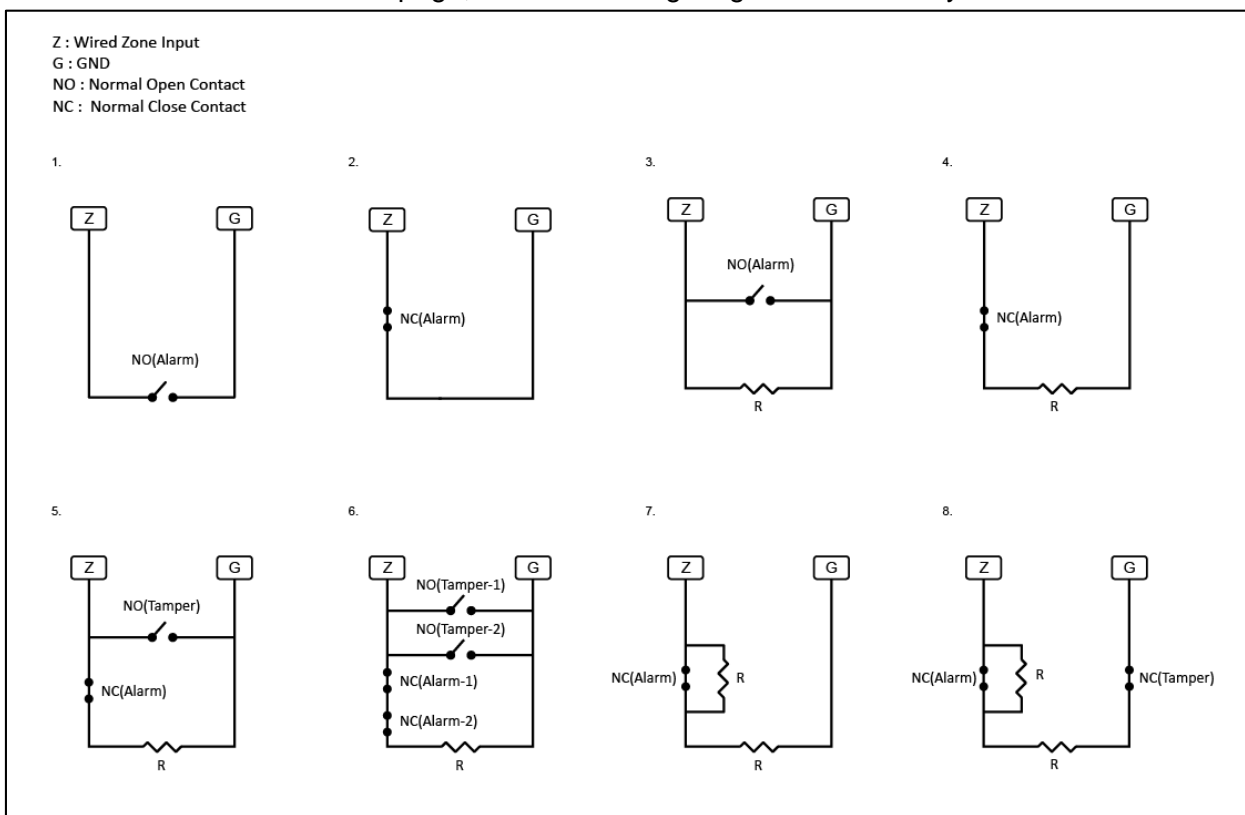

- **Resistor:** Select the resistance for the zone wiring.

Resistor
1K ohm
1K ohm
2.2K ohm
3.74K ohm
4.7K ohm
5.6K ohm
6.8K ohm
8.2K ohm
10K ohm
1K ohm
1K ohm

- **Status:** The status of each zone—Restore, Tamper, or Trigger—will be shown in this field.
- Step 4.** Click “OK” to save changes when finished. Alternatively, click “Reset” to re-enter all the information.
- Step 5.** If the process is successful, the screen will display “Updated Successfully.” The sensor will be assigned to specific area and zone. To edit the device setting or information, click “Edit” at the end of device entry.

Wired Sensors						
Zone	Type	Loop	Resistor	Status		
1	Door Contact	1	10K ohm	Restore	Area1Zone5 Edit	
2	(Disabled)	1	1K ohm	Restore		
3	(Disabled)	1	1K ohm	Restore		
4	(Disabled)	1	1K ohm	Restore		
5	(Disabled)	1	1K ohm	Restore		
6	(Disabled)	1	1K ohm	Restore		

Step 6. You will enter Device Edit webpage.

Climax

Device Edit

Door Contact

ID: IN:01

Version:

Capability:

Name:

Tag:

Area: 1

Zone: 5

Attribute: Permanently Bypass

Attribute: Latch report

Attribute: Set/Unset: Normal Close

Attribute: 24 HR: Burglar Alarm

Disarm Response: Chime

Full Arm Response: Start Entry Delay 1

Home Arm 1 Response: Start Entry Delay 1

Home Arm 2 Response: Start Entry Delay 1

Home Arm 3 Response: Start Entry Delay 1

Trigger Response: No Response

Restore Response: No Response

Exit: No Response

Or [Cancel](#)

Step 7. Edit your device setting and information according to instruction below. Click “OK” to save changes when finished. Alternatively, click “Default” to reset all parameters to default values or click “Reset” to re-enter all the information.

- **Name:** Enter a name for the device.
- **Area:** Select the area which the device belongs to.
- **Zone:** Select the Device zone number.
- **Attribute List:**
The attribute list determines panel behavior when the panel receives trigger signal from the device. There are

General Attribute:

Permanently Bypass

This function allows user to permanently deactivate (bypass) the selected device.

- If bypassed, then the Control Panel will not respond at all when the sensor is triggered.
- If bypassed, the system can be armed directly regardless the device's fault situation. However, its fault situation will still be monitored, logged and displayed in the webpage.

Latch report

This function **ONLY** applies to Remote Control or Door Contact with Set/Unset attribute enabled.

- Latch Report **ON**: When the device is used to change system arm mode, the Control Panel will report the arm/disarm action by the particular device.
- Latch Report **OFF**: When the device is used to change system arm mode, the Control Panel will not report the arm/disarm action by the particular device.

Set/Unset

This function is for Door Contact only. This function allows Door Contact to control system mode.

- **Normal Close**: The system will be armed when the Door Contact is opened, and disarmed when Door Contact is closed.
- **Normal Open**: The system will be armed when the Door Contact is closed, and disarmed when Door Contact is open.

24HR

This function enables the device to activated selected alarm event whenever it is triggered regardless of system mode. System mode response will be disabled if 24HR attribute is enabled.

System Mode Attributes:

The System Mode Attributes determines system behavior under particular arming mode when the sensor is triggered.

No Response

- When a sensor with **No Response** is triggered, the Control Panel will not respond.

Start Entry Delay 1/ Start Entry Delay 2

- When the system is under Full Arm or Home Arm mode, if a sensor with **Start Entry Delay 1/2** attribute is triggered, Control Panel will start an entry countdown period to give enough time to disarm the system.
- When the Control Panel is in the Disarm mode, if a sensor with **Start Entry Delay 1/2** attribute is triggered, the Control Panel will immediately report a burglar interior alarm (**CID code: 132**).
- When the Control Panel is in the Full Arm mode, if a sensor with **Start Entry Delay 1/2** attribute is triggered, the Entry Delay 1/2 timer starts counting down. If no correct pin code is entered during the entry delay timer to disarm the system, the Control Panel will report a burglar perimeter alarm (**CID code:131**) immediately after entry delay timer 1/2 expires.
- When the Control Panel is in the Home Arm 1/2/3 mode, if a sensor with **Start Entry Delay 1/2** attribute is triggered, the Entry Delay 1/2 timer starts counting down. If no correct pin code is entered during the entry delay period to disarm the system, the Control Panel will report a burglar interior alarm (**CID code: 132**) immediately after entry delay timer 1/2 expires.

Chime

- When the system is in Arm/ Home Arm 1/ Home Arm 2/ Home Arm 3 mode, if a sensor set to Chime is triggered, the Control Panel will sound a Door Chime (Ding-Dong Sound).

☞ [Burglar Follow](#)

- When the system is in Full Arm or Home Arm mode mode, if a sensor set to **Burglar Follow** is triggered, the Control Panel will report a burglar alarm immediately.
- When a Start Entry sensor is triggered and the system is under Entry Delay Timer countdown, if a sensor set to **Burglar Follow** is triggered, the Control Panel will wait until the Entry Delay Timer expires before activating a burglar alarm. If the system is disarmed before the timer expires, the Control Panel will not activate alarm.

☞ [Burglar Instant](#)

- When the system is under Full arm or Home Arm/ Disarm / Entry Time mode, if a sensor set to **Burglar Instant** is triggered, the Control Panel will report a burglar alarm immediately.

☞ [Burglar Outdoor](#)

- When the system is in Full Arm or Home Arm / Disarm / / Entry Time mode, if a sensor set to **Burglar Outdoor** is triggered, the Control Panel will report a burglar outdoor event immediately.

☞ [Cross Zone](#)

- See **10.3 Appendix – Cross Zone Verification** for detail.

☞ [Apply Scene](#)

- This function is only available for [Remote Keypad](#) and [Remote Control](#).
- Select a Home Automation Scene number for a Remote Keypad or Remote Control button. When the button is pressed, the Control Panel will execute the actions programming in the Scene accordingly. For more information, please refer to **8.3. Scene**.

Home Automation Attributes:

The Home Automation Attributes allows a device to control Home Automation function.

☞ [Trigger Response](#)

- When the device is triggered, the Control Panel will activated selected Home Automation Scene number. Please refer to **8.3. Scene** webpage for detail.

☞ [Restore Response](#)

- When the device transmits restore signal after trigger, the Control Panel will activate selected Home Automation Scene number.

Other Attributes:

☞ [Permanent Bypass](#)

- When checked, the panel will completely ignore all signal received from this device. A bypassed device will be unable to trigger any response, including alarm or fault from the Control Panel. All other attribute settings will be also be ignored.

☞ [Exit \(No Response\)](#)

- If checked, the panel will ignore trigger signal from this sensor during Exit Time

countdown. If deselected, the panel will activated burglar alarm and report immediately when the sensor triggered during Exit Delay Timer.

☞ **24HR**

- A sensor set to 24HR attribute will ignore Disarm, Full Arm, Home are and Exit response setting. The panel will activate selected alarm when this sensor is triggered regardless of system mode under any time.

<NOTE>

☞ Some devices have their own unique functions and will have its own attribute setting which is not listed in this section. Please refer to the device manual for its setting detail.

Step 7. If you want to delete the sensor, refer to step 2 and select “**Disabled**” from the drop down menu of **Type** to delete it. If the process is successful, the screen will display “**Updated Successfully.**”

6. System Settings

After the initial set-up, you can then program your system by clicking on the left menu to set them individually.

6.1. Panel Condition

In the **Panel** Section, user can arm, disarm or partially arm the system. Besides, it displays the current **Panel Status & Device Information**.

The screenshot shows the Climax web interface. The left sidebar menu has 'Panel' highlighted. The main content area is titled 'Panel Control' and contains the following sections:

- Area 1:** Current mode: Disarm. Radio buttons for Disarm, Full Arm, Home Arm 1, Home Arm 2, and Home Arm 3. OK and Reset buttons.
- Area 2:** Current mode: Disarm. Radio buttons for Disarm, Full Arm, Home Arm 1, Home Arm 2, and Home Arm 3. OK and Reset buttons.
- Panel Status:** A table showing the status of various components.

Battery	Tamper	Interference	AC activation	Signal GSM	Background RSSI
Normal	Normal	Normal	Normal	9	1
- Test System:** OK button.
- System in maintenance:** Section with a 'Fault Status' table.

Fault	Setting
Area1Zone6 Tamper	<input checked="" type="checkbox"/> Clear
- Device List:** A table showing the status of various devices.

Area	Zone	Type	Name	Condition	Battery	Tamper	Bypass	RSSI	Status	
1	1	Keypad		Normal	Normal	Normal	No	Strong		Edit Delete
1	2	Remote Controller		Normal	Normal	Normal	No	Strong		Edit Delete
1	3	WTRV		Normal	Normal	Normal	No	N/A		Edit Delete
1	4	IR Camera		Normal	Normal	Normal	No	Good		Edit Delete
1	5	809		Normal	Normal	Normal	No	Strong		Edit Delete
1	6	Door Contact		Normal	Normal	Tamper	No	Strong	DC Open	Edit Delete

Panel Control

Select a choice to arm, disarm or partially arm the system.

Panel Status

The Control Panel will update the panel status periodically. However, in order to show the current status, you must reload the screen to refresh the display.

- **Battery:** When battery is running low, a “low battery” message will be displayed to inform you to recharge the battery.
- **Tamper:** (reserved)
- **Interference:** This is for you to check whether the Control Panel is purposely interfered. The jamming period detected will be accumulated, and when the total period exceeds 30 seconds within 1 minute, a “Jamming” message will be shown and reported to the Central Monitoring Station accordingly.

- **AC activation:** To check whether AC power is connected. If not, it will show “AC Failure”.
- **Background RSSI:** RSSI value is for you to check the RF environment around the Control Panel. It ranges from 0 to 9, where 0 refers to the weakest and 9 refers to the strongest background noise. Therefore, the lower the RSSI value, the better the environment.

Test System

The function is designed to send a command to sever over the polling or XMPP protocol.

Fault Status

Fault Status	
Fault	Setting
Area1Zone6 Tamper	<input checked="" type="checkbox"/> Clear

OK Reset

The fault events that exist in the alarm system are displayed under this section. When fault event exists in system, the control panel Fault LED will light up to indicate fault status under Disarm or Home Arm mode (The Fault LED will not light up under Arm mode).

When fault event exists, and you attempt to arm the system, the arming action will be prohibited and the panel will display fault information on the webpage. If you still want to arm the system, perform the arming action again to force arm.

You can check the “Clear” box in the setting column then click “OK” to ignore the fault event. Cleared fault event will not cause the Fault LED to light up, nor prohibit arming.

Device List

1. The Control Panel will update the device information periodically. However, in order to show the current status, you must **reload** the screen to refresh the display.

➤ **Area:** operation area

- **Zone:** device zone
- **Type:** device type
- **Name:** device title
- **Status:** device’s current status, such as tamper status, battery status, out of order condition or DC open. If PSM is added into the system, the data of PSM, such as On/Off status, voltage, electric current and watt, will be displayed.

2. Under **Device**, you could further **edit** or **delete** an added device (please refer to 5.1.3 and 5.1.4 for details). Beside, you can reset Panel settings or clear the system faults by pressing **Reset Panel**.

Device List										
Area	Zone	Type	Name	Condition	Battery	Tamper	Bypass	RSSI	Status	
1	2	UPIC		█	█	█	No	Strong, 7		Edit Delete
1	3	IR		█	█	█	No	Strong, 8		Edit Delete
1	6	Keypad		█	█	█	No	Strong, 6		Edit Delete

- After pressing **Reset Panel**, the Control Panel will restart in 60 seconds and all configured

values will be kept without any change.

Note

Note			
No.	Type	Description	
#1			Edit
#2			Edit
#3			Edit
#4			Edit
#5			Edit

The function is designed for installer to make a note for each control panel. The note you make here can be delivered to a server over XMPP or polling protocol.

6.2. Panel Settings

Program the **Panel, Time** and **Sound Settings** at your discretion.

Panel Setting

AC Fail Report 5 min ▼
 AC Fail Suspend 5 sec ▼
 Jamming Report 1 min ▼
 Auto Check-in Interval 12 hr ▼
 Auto Check-in Offset Period 1 hr ▼
 IR Camera Resolution of Alarm Images 320x240x3 images ▼
 Outdoor IR Camera in Grayscale Disable ▼
 Bypass Ethernet No ▼
 OK Reset

Area Setting

Area 1 ▼
 Final Door Off ▼
 Arm Fault Type Confirm ▼
 Tamper Alarm Full Arm ▼
 Supervision Check Off ▼

Time Setting

Supervision Timer Disable ▼
 Entry Delay 1 for Full Arm Disable ▼
 Entry Delay 2 for Full Arm Disable ▼
 Exit Delay for Full Arm Disable ▼
 Entry Delay 1 for Home Arm Disable ▼
 Entry Delay 2 for Home Arm Disable ▼
 Exit Delay for Home Arm Disable ▼
 Alarm Length Disable ▼
 Cross Zone Timer Disable ▼
 Fire Verification Timer Disable ▼

Sound Setting

Door Chime Setting Off Low High
 Entry Delay Sound for Full Arm Off Low High
 Exit Delay Sound for Full Arm Off Low High
 Entry Delay Sound for Home Arm Off Low High
 Exit Delay Sound for Home Arm Off Low High
 Confirm Sound Off Low High
 Warning beep Off Low High
 Entry/Exit Only Final Beeps Disable ▼
 OK Reset

Panel Setting

- **AC Fail Report:** When an AC power failure is detected, your Control Panel will report to the Central Monitoring Station according to the duration set under AC Fail Report. If 5 minutes is set, the event will be automatically reported to the CMS after 5 minutes. Your Control Panel will start to use its battery power instead of the mains power until the fault even is cleared.
- **AC Fail Suspend:** After an AC power failure event is reported, the Control Panel will

convert to sleep mode to conserve battery power. During this period, both GSM and Ethernet port will be powered off, while the RF modules will keep working. If 5 seconds is set, both GSM and Ethernet port will be powered off after 5 seconds. In order to send messages to the CMS, the Control Panel will power on its GSM and Ethernet temporarily.

- **Jamming Report:** this function is reserved.
- **Auto Check-in:** this is to select whether the Control Panel needs to send check-in reporting to the Central Station automatically and to select the period of time between check-in reports. Options available are **Disable, 1 hour, 2 hours, 3 hours... up to 4 Weeks.**
- **Auto Check-in Offset Period:** This is to set the time delay before the first **Auto Check-In** report is made. After power is supplied or re-supplied to the Control Panel, a test report will be sent to the Central Monitoring Station (CMS) based on the Offset Period. This is used to test whether the CMS is able to receive the report from the Panel accurately.

After this test report is sent, the Control Panel will then send reports at regular interval based on the setting of the Auto Check-in Report.

For example, if **Offset Period** is set to 2 Hours, and **Auto Check-in Report** is set to 12 hours, the Control Panel will transmit an event code 602 to the CMS after 2 hours, and then report 602 event code periodically at a regular intervals of 12 hours.

- **IR Camera Resolution of Alarm Images:** This is to select the resolution and number of pictures taken by PIR Camera when the camera detects a movement in armed mode.
Options available are **320x240x3 images (Default), 320x240x6 images and 640x320x3 images.**
- **Outdoor IR Camera in Grayscale:** This is to select whether pictures from Outdoor PIR Camera should be taken in grayscale instead of color pictures.
Options available are: **Disable** (Color Picture) and **Enable** (Greyscale picture)
- **Bypass Ethernet:** Select to enable or disable Bypass Ethernet function. When **YES** is selected, the Control Panel will bypass connection fault when Ethernet cable unplugged status is detected.

Area Setting

- **Area:** Select operation area to apply setting.
- **Final Door:** If set to **On:** When the system is Away Armed and under exit timer countdown, if a opened Door Contact set to Entry attribute is closed, the system will automatically arm the system even if the exit delay timer has not expired yet.
- **Arm Fault Type:** Select how the system should respond when it is being armed under fault condition.
 - ✓ Confirm: The panel will first display a "Mode Change Fault" message and emit 2 beeps. Arming again within 10 seconds will force arm the system.
 - ✓ Direct Confirm: The system will be force armed directly without displaying fault message and report an event.
- **Tamper Alarm:** Select whether the siren should sound alarm when the tamper is triggered.
 - ✓ Full Arm: when tamper is triggered under Full arm mode, Control Panel raises a local alarm and sends report to the monitoring center. While under Home Arm or Disarm modes no alarm will be activated, nor report sent.
 - ✓ Always: Control Panel raises a local alarm and send report for tamper-trigger in all modes.

- **Supervision Check:** Select to enable or disable system supervision function. When **ON** is selected, the Control Panel will monitor the accessory devices according to the supervision signal received.

Time Setting

- **Supervision Timer:** The Control Panel monitors accessory devices according to the supervision signal transmitted regularly from the device. User this option to set a time period for receiving supervision signals. If the Control Panel fails to receive supervision signal from a device within this duration, it will consider the device out of order and report the event accordingly.
- **Entry Delay 1 for Full Arm:** Set Entry Delay Timer 1 for full arm mode. When a sensor set to Start Entry Delay 1 is triggered under Full Arm mode, the control panel will begin Entry Delay Timer countdown according to duration set with this option

If the Control Panel is disarmed before the Entry Delay Timer expires, the panel returns to Disarm mode and no alarm is activated. If the Control Panel is not disarmed before the Entry Delay Timer expires, the alarm will be activated and the panel will send report.
- **Entry Delay 2 for Full Arm:** Set Entry Delay Timer 2 for full arm mode. When a sensor set to Start Entry Delay 2 is triggered under Full Arm mode, the control panel will begin Entry Delay Timer countdown according to duration set with this option

If the Control Panel is disarmed before the Entry Delay Timer expires, the panel returns to Disarm mode and no alarm is activated. If the Control Panel is not disarmed before the Entry Delay Timer expires, the alarm will be activated and the panel will send report.
- **Exit Delay for Full Arm:** Set the Exit Delay Timer when entering Full Arm mode. When the user changes system mode to Full Arm, the panel will begin Exit Delay Timer Countdown and enter Full Arm mode when the timer expires. The user must leave area protected by sensors before the timer expires, otherwise an alarm will be activated with the sensor is triggered.
- **Entry Delay 1 for Home Arm:** Set Entry Delay Timer 1 for Home Arm mode. When a sensor set to Start Entry Delay 1 is triggered under Home Arm mode, the control panel will begin Entry Delay Timer countdown according to duration set with this option

If the Control Panel is disarmed before the Entry Delay Timer expires, the panel returns to Disarm mode and no alarm is activated. If the Control Panel is not disarmed before the Entry Delay Timer expires, the alarm will be activated and the panel will send report.
- **Entry Delay 2 for Home Arm:** Set Entry Delay Timer 2 for Home Arm mode. When a sensor set to Start Entry Delay 2 is triggered under Home Arm mode, the control panel will begin Entry Delay Timer countdown according to duration set with this option

If the Control Panel is disarmed before the Entry Delay Timer expires, the panel returns to Disarm mode and no alarm is activated. If the Control Panel is not disarmed before the Entry Delay Timer expires, the alarm will be activated and the panel will send report.
- **Exit Delay for Home Arm:** Set Exit Delay Timer for Home Arm mode. When the user changes system mode to Home Arm, the panel will begin Exit Delay Timer Countdown and enter Home Arm mode when the timer expires. The user must leave area protected by sensors before the timer expires, otherwise an alarm will be activated with the sensor is triggered (Default as 10 seconds).
- **Alarm Length:** Set the duration the external siren should sound when an alarm is activated.
- **Cross Zone Timer:** Please refer to **10.3 Cross Zone Timer** for details
- **Fire Verification Time:** Please refer to **10.4 Fire Verification Timer** below for details.

Sound Setting

- **Door Chime Setting:** this function is available only when the attribute of Door Contact (DC) and/or PIR detector (IR) is set as **Door Chime**.
The Control Panel sounds a Door Chime (Ding-Dong Sound) while the DC and/or IR is activated in Disarm / Full / Home / Entry mode.
- **Entry Delay Sound for Full Arm:** this is for you to decide whether the Control Panel sounds count-down beeps and volume of beep during the entry delay time in the full arm mode.
- **Exit Delay Sound for Full Arm:** this is for you to decide whether the Control Panel sounds count-down beeps and volume of beep during the exit delay timer in the full arm mode.
- **Entry Delay Sound for Home Arm:** this is for you to decide whether the Control Panel sounds count-down beeps and volume of beep during the entry delay time in the home arm mode.
- **Exit Delay Sound for Home Arm:** this is for you to decide whether the Control Panel sounds count-down beeps and volume of beep during the exit delay timer in the home arm mode.
- **Confirm Sound:** this is for you to decide whether to turn off/or adjust Control Panel beeping sounds when changing Arm/Home Arm/Disarm mode.
- **Warning beep:** this is for you to decide whether the Control Panel will sound a warning beep whenever a fault condition has been detected and displayed. The warning beep will be silenced after the Fault message has been read by the user. When a new fault condition is detected, it will then again emit a warning beep every 30 sec.
- **Entry/ Exit Only Final Beeps:** This is for you to determine when the Control Panel should start warning beep during Entry or Exit countdown timer. For example, if the setting is set to 5 seconds, the Control Panel will only start warning beep during the last 5 seconds of Entry or Exit countdown timer. When set to Disable, the Control Panel will sound warning beep during the entire Entry or Exit countdown timer.

6.3. PIN Code

The User PIN Codes are used by Remote Keypad accessory to control system mode remotely. The 2 areas in the control panel each has 80 User PIN Codes available for setting. Each consists of 4-6 digits (numeric number 0~9), no disallowed PIN code. User PIN code #1 for each Area is always activated factory default.

User PIN #1 in Area 1

Password: **1234**

User PIN #1 in Area 2

Password: **4321**

No.	User Code	User Name	Latch	Delete
1	1234	user	<input checked="" type="checkbox"/>	<input type="checkbox"/>
2			<input type="checkbox"/>	<input type="checkbox"/>
3			<input type="checkbox"/>	<input type="checkbox"/>
4			<input type="checkbox"/>	<input type="checkbox"/>
5			<input type="checkbox"/>	<input type="checkbox"/>
6			<input type="checkbox"/>	<input type="checkbox"/>
7			<input type="checkbox"/>	<input type="checkbox"/>
8			<input type="checkbox"/>	<input type="checkbox"/>
9			<input type="checkbox"/>	<input type="checkbox"/>
10			<input type="checkbox"/>	<input type="checkbox"/>
11			<input type="checkbox"/>	<input type="checkbox"/>
12			<input type="checkbox"/>	<input type="checkbox"/>
13			<input type="checkbox"/>	<input type="checkbox"/>
14			<input type="checkbox"/>	<input type="checkbox"/>
15			<input type="checkbox"/>	<input type="checkbox"/>
16			<input type="checkbox"/>	<input type="checkbox"/>
17			<input type="checkbox"/>	<input type="checkbox"/>
18			<input type="checkbox"/>	<input type="checkbox"/>
19			<input type="checkbox"/>	<input type="checkbox"/>
20			<input type="checkbox"/>	<input type="checkbox"/>
21			<input type="checkbox"/>	<input type="checkbox"/>
22			<input type="checkbox"/>	<input type="checkbox"/>
23			<input type="checkbox"/>	<input type="checkbox"/>
24			<input type="checkbox"/>	<input type="checkbox"/>
25			<input type="checkbox"/>	<input type="checkbox"/>
26			<input type="checkbox"/>	<input type="checkbox"/>
27			<input type="checkbox"/>	<input type="checkbox"/>
28			<input type="checkbox"/>	<input type="checkbox"/>
29			<input type="checkbox"/>	<input type="checkbox"/>
30			<input type="checkbox"/>	<input type="checkbox"/>

Area

Area: Select the area for setting User PIN Code.

User Code Setting

- **User Code:** Enter the 4-digit code in the field.
- **User Name:** Enter a user name for easy recognition of system events. Up to 17 alphanumerical characters are allow for each user name.
- **Latch:**
 - Latch → **Latch Report ON** = Whenever the User PIN Code is used to change system mode, the panel will report the event.
 - Latch → **Latch Report OFF** = When the User PIN Code is used to change system mode, the panel will not report the event.
- **Delete:** Check the box if you want to delete selected user. User#1 in each area cannot be deleted

After finish all setting, click **OK** to confirm change.

7. Network Settings

7.1. GSM

GSM
Status: Insert SIM, IMEI: 861412042028550, IMSI:

Check SIM
Test present of SIM card No Yes

Antenna
Choose GSM antenna Internal External
OK Reset

GPRS
APN
User
Password
OK Reset

MMS
APN
User
Password
URL
Proxy Address
Proxy Port 8080
OK Reset

SMS
SMS Keyword
SMS P-word PROG
OK Reset

Two-Way Setting
Speaker 7
Microphone 7
OK Reset

[Send SMS...](#)
GSM Reset

Check SIM

This is designed for the system to check if the SIM card is inserted or not. (***If users do not intend to use the GSM function, please tick “NO” to ensure the system will not check if the SIM card is inserted or not and it will not display the GSM fault by LED flashing.***)

Antenna

This option is for the user to choose between using the internal or external antenna.

GPRS

In order to allow GPRS to serve as a back-up IP Reporting method, this section will need to

be programmed before reporting.

- **APN (Access Point) Name**

It is the name of an access point for GPRS. Please inquire your service provider for an APN. When APN is set, the system becomes valid for internet connection.

- **User (GPRS)**

It is the Log-in name to input before accessing the GPRS feature. Please inquire your service provider.

- **Password (GPRS)**

It is the User Password to input before accessing the GPRS feature. Please inquire your service provider.

<NOTE>

- All values will be applied to both Areas 1 & 2.

MMS

The MMS settings are offered by your telecom service provider. Before configuring this function, contact your service provider for correct MMS setting information of the inserted SIM card.

- **APN (Access Point) Name**

Enter a MMS APN name provided by your service provider.

- **User**

Enter the Log-in name for accessing the MMS feature provided by your telecom service provider.

- **Password**

Enter the password for accessing the MMS feature provided by your telecom service provider.

- **URL**

Enter the MMS APN URL provided by your telecom service provider.

- **Proxy Address**

Enter the MMS Proxy Address provided by your telecom service provider.

- **Proxy Port**

Enter the MMS Proxy Port provided by your telecom service provider.

SMS

- **SMS Keyword**

For sending remote commands to system via SMS message, a personalized password is required for the Control Panel to recognize your authority.

- **SMS P-Word**

Program Keyword is used to recognize the identity of a valid user; and to give authority for Remote Installing (through SMS Text) or Remote Upgrading purposes (through GPRS). This keyword will need to be inserted whenever the Remote Setting or Remote Upgrading is required. A maximum of 15 characters is allowed.

Two Way Setting

The two-way setting is designed to adjust speaker volume and microphone sensitivity on device for two-way communication.

Two-Way Setting

Speaker

Microphone

[Send SMS...](#)
[GSM Reset](#)

Send SMS Message

This feature is designed for you to send a SMS message on this web configuration page.

Step 1. Click **Send SMS**.

Two-Way Setting

Speaker

Microphone

[Send SMS...](#)
[GSM Reset](#)

Step 2. Enter a desired phone number and text message.

Send SMS

Phone Number:

Text:

Reset GSM

This feature is designed for you to reset GSM module.

Step 1. Click **GSM Reset**.

Two-Way Setting

Speaker

Microphone

[Send SMS](#)
[GSM Reset](#)

Step 2. A pop-out message “Are you sure?” is displayed. Click **Yes** to confirm resetting.

7.2. Network

This is for you to program the Network for IP connection.

The screenshot displays the 'Network' configuration page in the Climax web interface. The sidebar on the left lists various system settings, with 'Network' selected and highlighted in red. The main content area is titled 'Network' and features two radio button options: 'Obtain an IP address automatically (DHCP)' (which is selected) and 'Use the following IP address'. Below these options are several input fields for manual configuration: IP Address (192.168.0.1), Subnet Mask (255.255.255.0), Default Gateway (192.168.0.254), Default DNS 1 (192.168.0.100), and Default DNS 2 (192.168.0.101). A 'DNS Flush Period' dropdown menu is set to 'Disable'. At the bottom of the configuration area are 'OK' and 'Reset' buttons. The footer of the interface indicates the copyright year as 2016 for Climax Tech. Co., Ltd.

- **Obtain an IP address automatically (DHCP)**

If DHCP is selected, the Network will obtain an IP address automatically with a valid Network DHCP Server. Therefore, manual settings are not required.

This is only to be chosen if your Network environment supports DHCP. It will automatically generate all information.

- **Use following IP address**

You can also enter the Network information manually for IP Address, Subnet Mask, Default Gateway, Default DNS 1 and Default DNS 2.

Please make sure that you have obtained all required values according to your Network environment. Please contact your network administrator and/or internet service provider for more information.

- **DNS Flush Period**

You can set the system to clear current DNS resolution records for all entered URL settings (Reporting, Upload, XMPP...etc.) after a set time period. The system will then resolve the Domain Name again and acquire new IP address for the URL settings. This function is disabled by default.

7.3. UPnP

UPnP is Universal Plug and Play, which opens networking architecture that leverages TCP/IP and the Web technologies to enable seamless proximity networking in addition to control and data transfer among networked devices in the home, office, and public spaces.

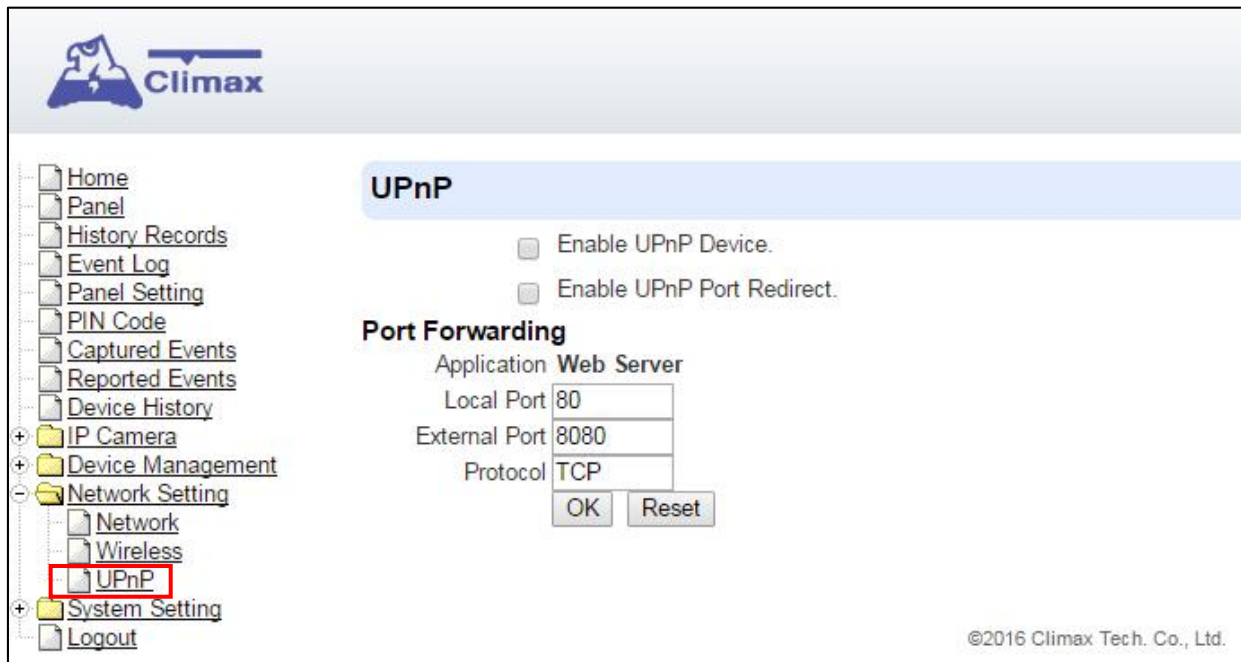

- **Enable UPnP Device:**

When enabled, you will be able to see this device via any UPnP discovery tool

- **Enable UPnP Port Redirect:**

The device will try to find an UPnP-supported router and set up the port to redirect to the router.

- **Port Forwarding:**

Port forwarding function allows you to configure specific communication ports to be routed to your system over the Internet for users to access their IP camera(s) remotely.

1. **Local Port:** type 80.

2. **External Port:** type 8080.

3. **Protocol:** type TCP.

After port forwarding has been set up, the router will forward incoming requests on port that your IP Camera users. To set up port forwarding on your router, please refer to your router's instruction manuals for detail.

8. System Settings

8.1. Administrator Setting

For setting new Administrator Log-in Name and Password. Please note both User Name and Password are **case sensitive**.

Step 1. Enter the preferred **User Name**.

Step 2. Enter the preferred **Password** in the “New Password” field and repeat the same Password in the **Repeat Password** field.

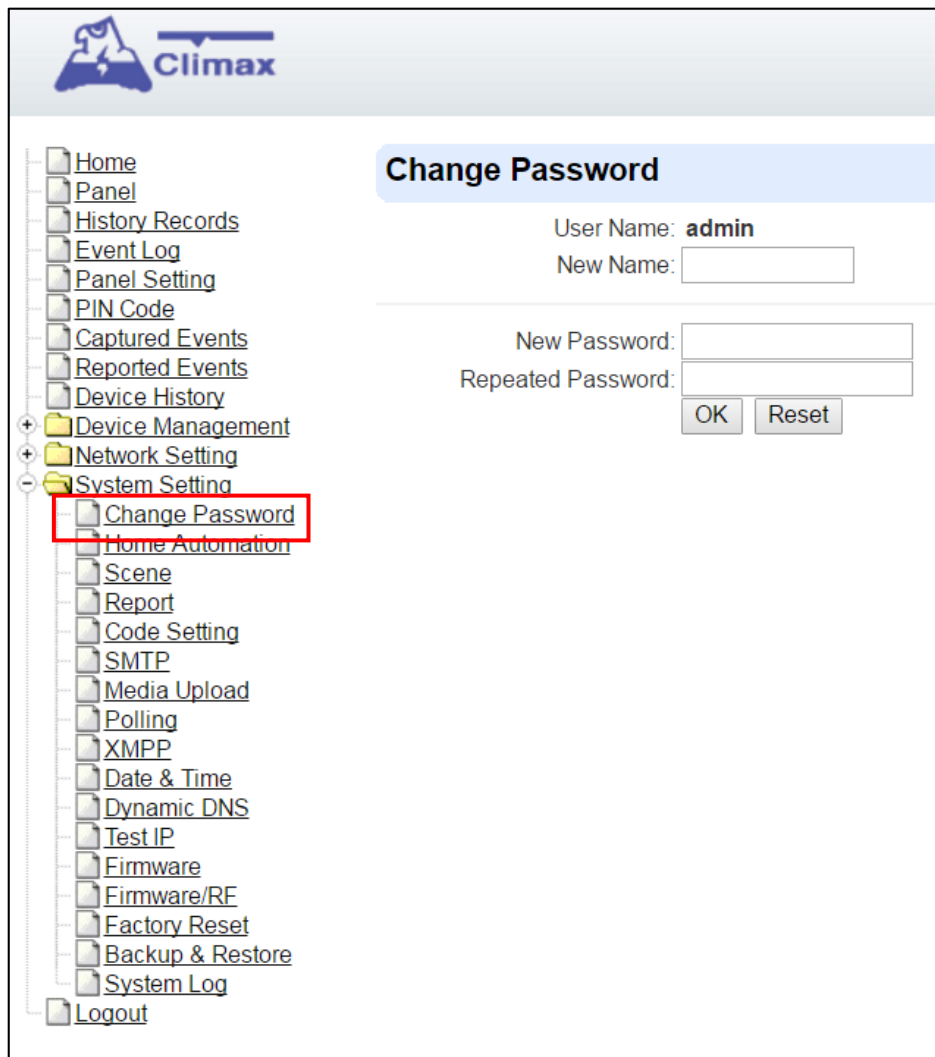

The screenshot displays the Climax web interface. On the left is a sidebar menu with a tree structure. The 'System Setting' folder is expanded, and the 'Change Password' option is highlighted with a red rectangle. The main content area is titled 'Change Password' and contains the following fields and buttons:

- User Name: **admin**
- New Name:
- New Password:
- Repeated Password:
- Buttons:

8.2. Home Automation

It is used to set Home Automation rules to control sensors and home appliances. You can set up to 100 rules.

- Step 1.** Click on **Edit**.
- Step 2.** Select an operation area.
- Step 3.** Set a rule condition.
- Step 4.** Set a rule schedule.
- Step 5.** Select the corresponding action rules in the **Execution** field.

#	Area	Rule Condition	Rule Schedule	Execution	
1		Empty	Always	Empty	Edit
2		Empty	Always	Empty	Edit
3		Empty	Always	Empty	Edit
4		Empty	Always	Empty	Edit
5		Empty	Always	Empty	Edit
6		Empty	Always	Empty	Edit
7		Empty	Always	Empty	Edit
8		Empty	Always	Empty	Edit
9		Empty	Always	Empty	Edit
10		Empty	Always	Empty	Edit
11		Empty	Always	Empty	Edit
12		Empty	Always	Empty	Edit
13		Empty	Always	Empty	Edit
14		Empty	Always	Empty	Edit
15		Empty	Always	Empty	Edit

- **Area**
Select an operation area.
- **Rule Condition**
The rule condition determines under which circumstances the rule should be activated.
 - ☞ **Empty** : When set as **Empty**, the system will follow the schedule time and execution rule to respond accordingly.
 - ☞ **Trigger Alarm** : When set as **Trigger Alarm**, if the specified alarm event (Burglar/Smoke/Medical/Water/Silent Panic/Panic/Emergency/Fire/CO Alarm/Gas/Heat) or any alarm is triggered, the rule will be activated according to rule schedule and execution setting.

- ☞ **Mode Change** : When set as **Mode Change**, when the system enters specified mode, the rule will be activated according to rule schedule and execution setting.

☞ **Mode Change and Exit Timer Stopped** : When set as **Mode Change and Exit Timer Stopped**, when the system changes mode to and Exit Delay Timer expires, , the rule will be activated according to rule schedule and execution setting.

☞ **Mode Start Entry Timer** : When set as **Mode Start Entry Timer**, when the system begins to countdown Entry Delay, the rule will be activated according to rule schedule and execution setting.

☞ **Temperature Below** : When set as **Temperature Below**, if the temperature detected by specified temperature sensor drops below set threshold, the rule will be activated according to rule schedule and execution setting.

☞ **Temperature Above** : When set as **Temperature Above**, if the temperature detected by specified temperature sensor exceeds set threshold, the rule will be activated according to rule schedule and execution setting.

☞ **Temperature Between** : When set as **Temperature Between**, if the temperature detected by specified temperature sensor falls within the range specified, the rule will be activated according to rule schedule and execution setting.

☞ **High Power Consumption** : When set as **Power Consumption Above**, if the power output watt from a specific Power Switch exceeds, the rule will be activated according to rule schedule and execution setting.

☞ **Humidity Above** : When set as **Humidity Above**,if the humidity reading from specified room sensor rises above the level specified, the rule will be activated according to rule schedule and execution setting.

☞ **Humidity Below** : When set as **Humidity Below**,if the humidity reading from specified room sensor falls below the level specified, the rule will be activated according to rule schedule and execution setting.

- ☞ **LUX Between** : When set as **LUX Between**, if the lux reading from specified light sensor falls below the level specified, the rule will be activated according to rule schedule and execution setting.

- ☞ **Random** : The **Random** condition must be used along with Rule Schedule setting. Set a percentage from 1 to 10%. When the panel time reaches programmed Rule Schedule time. The Panel will activate rule according to set chance.

Example: If set as 10%, whenever the panel reaches programmed Rule Schedule time, there will be a 10% chance the rule is activated.

● Rule Schedule

- ☞ **Always** : When set as **Always**, the rule can be activated anytime.

- ☞ **Once** : When set as **Once**, the system will follow the rule condition and execute rule according to the exact date and time specified..

- ☞ **Every Month** : When set as **Every Month**, the system will follow the rule condition and execute rule according to date and time specified every month.

- ☞ **Every Week** : When set as **Every Week**, the system will follow the rule condition and execute rule according to day of the week and time specified every week.

- ☞ **Every Day** : When set as **Every Day**, the system will follow the the rule condition and execute rule according to time specified every day

● Execution

Execution is the actual action performed by Control Panel when both Rule Condition and Rule Schedule requirements are met

- ☞ **Zone Switch Off:** Turn on the Power Switch at specified zone.

- ☞ **Zone Switch On** : Turn on the Power Switch at specified zone.

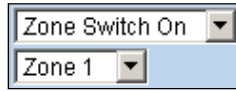

☞ **Zone Switch On For** : Turn on the Power Switch at specified zone for a set duration.

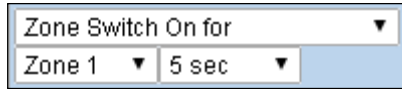

☞ **Zone Switch Level**: Change the power output level for Dimmer at specified zone.

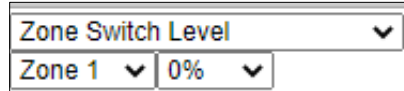

☞ **Zone Switch Toggle** : Toggle on/off the Power Switch at specified zone.

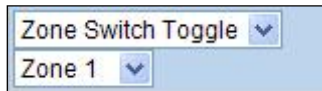

☞ **Group Switch Off** : Turn off all Power Switches assigned to specified group.

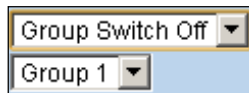

☞ **Group Switch On** : Turn on all Power Switches assigned to specified group.

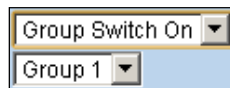

☞ **Group Switch On For** : Turn on all Power Switches assigned to specified group for a set duration.

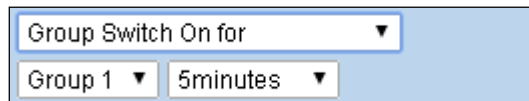

☞ **Group Switch Level** : Change the power output level for Dimmer at specified group.

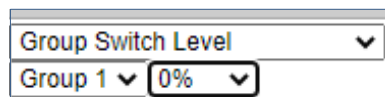

☞ **Group Switch Toggle** : Toggle on/off the Power Switch at specified group.

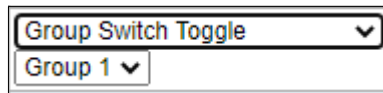

☞ **Mode Change** : The system will change to the mode as you specified.

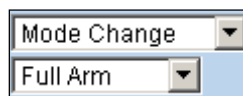

☞ **Request Image** : The PIR Camera in specified zone will take a picture.

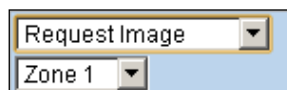

☞ **Request Image (All)** : All PIR Cameras in the system will take a picture.

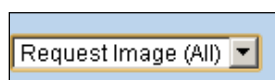

- ☞ **Request Image (No Flash)**: The PIR Camera in specified zone will take a picture without activating its LED flash.

- ☞ **Request Image (All, No Flash)**: All PIR Cameras in the system will take a picture without activating LED Flash.

- ☞ **Request Video**: The PIR Video Camera or IP Camera in specified zone will record a video.

- ☞ **Request Video (All)**: All PIR Video Cameras and IP Cameras in the system will record a video.

- ☞ **Setup UPIC**: The UPIC and specified zone will transmit Off/Heat/Cool command to the air conditioner as programmed.

- ☞ **Hue Control**: Adjust the hue and saturation of the Philips Hue at specified zone as programmed.

- ☞ **Trigger Alarm**: Choose to activate one of the following alarms: High Temperature Alarm, Low Temperature Alarm, High Power Consumption Alarm, High Humidity Alarm and Low Humidity Alarm

- ☞ **Apply Scene**: the system will execute preprogrammed Scene number. Please refer to 8.3. Scene for detail.

8.3. Scene

The Scene setting allows you to customize a series of actions with your devices, such as Power Switch control, image/video request, mode change and trigger alarm. The programmed scene can be set to activated when a device is triggered. (See **5.1.3. Edit Devices**), or when a Home Automation Rule is executed. (See **8.2. Home Automation**) For example, you can set a scene to control multiple lightings, then set your Remote Controller to activate the scene when the button is pressed, or set a Home Automation Rule to activate the scene.

Scene					
#	Name	#	Area	Execution	
1	Empty	1	1	Empty	<input type="button" value="Edit"/> <input type="button" value="Delete"/>
		2	1	Empty	
		3	1	Empty	
		4	1	Empty	
		5	1	Empty	
2	Empty	1	1	Empty	<input type="button" value="Edit"/> <input type="button" value="Delete"/>
		2	1	Empty	
		3	1	Empty	
		4	1	Empty	
		5	1	Empty	
3	Empty	1	1	Empty	<input type="button" value="Edit"/> <input type="button" value="Delete"/>
		2	1	Empty	
		3	1	Empty	
		4	1	Empty	
		5	1	Empty	
4	Empty	1	1	Empty	<input type="button" value="Edit"/> <input type="button" value="Delete"/>
		2	1	Empty	

Step 1. Click on **Edit**.

#	Name	#	Area	Execution	
1	<input type="text"/>	1	1 ▼	Empty ▼	<input type="button" value="Done"/>
		2	1 ▼	Empty ▼	
		3	1 ▼	Empty ▼	
		4	1 ▼	Empty ▼	
		5	1 ▼	Empty ▼	

Step 2. Enter a name for the scene.

Step 3. Select an Area

Step 4. Select an action to be executed when the scene is activated. Refer to the Rule Execution section in **8.2. Home Automation** for detail.

Step 5. Repeat Step 2-3 to setup the execution you wanted. As many as 5 executions can be

included in one scene.

Step 6. Click “**Done**”.

Step 7. Click “**OK**” at bottom of webpage to confirm the new scene setting..

8.4. Reporting

This is used for installer to program/ set all requirements for reporting purposes.

#	Reporting URL	Level	Group 1	Group 2	Group 3	Group 4	Group 5
1		All events ▼	<input type="radio"/>	<input type="radio"/>	<input type="radio"/>	<input type="radio"/>	<input type="radio"/>
2		All events ▼	<input type="radio"/>	<input type="radio"/>	<input type="radio"/>	<input type="radio"/>	<input type="radio"/>
3		All events ▼	<input type="radio"/>	<input type="radio"/>	<input type="radio"/>	<input type="radio"/>	<input type="radio"/>
4		All events ▼	<input type="radio"/>	<input type="radio"/>	<input type="radio"/>	<input type="radio"/>	<input type="radio"/>
5		All events ▼	<input type="radio"/>	<input type="radio"/>	<input type="radio"/>	<input type="radio"/>	<input type="radio"/>
6		All events ▼	<input type="radio"/>	<input type="radio"/>	<input type="radio"/>	<input type="radio"/>	<input type="radio"/>
7		All events ▼	<input type="radio"/>	<input type="radio"/>	<input type="radio"/>	<input type="radio"/>	<input type="radio"/>
8		All events ▼	<input type="radio"/>	<input type="radio"/>	<input type="radio"/>	<input type="radio"/>	<input type="radio"/>
9		All events ▼	<input type="radio"/>	<input type="radio"/>	<input type="radio"/>	<input type="radio"/>	<input type="radio"/>
10		All events ▼	<input type="radio"/>	<input type="radio"/>	<input type="radio"/>	<input type="radio"/>	<input type="radio"/>
11		All events ▼	<input type="radio"/>	<input type="radio"/>	<input type="radio"/>	<input type="radio"/>	<input type="radio"/>
12		All events ▼	<input type="radio"/>	<input type="radio"/>	<input type="radio"/>	<input type="radio"/>	<input type="radio"/>
13		All events ▼	<input type="radio"/>	<input type="radio"/>	<input type="radio"/>	<input type="radio"/>	<input type="radio"/>
14		All events ▼	<input type="radio"/>	<input type="radio"/>	<input type="radio"/>	<input type="radio"/>	<input type="radio"/>
15		All events ▼	<input type="radio"/>	<input type="radio"/>	<input type="radio"/>	<input type="radio"/>	<input type="radio"/>
16		All events ▼	<input type="radio"/>	<input type="radio"/>	<input type="radio"/>	<input type="radio"/>	<input type="radio"/>
17		All events ▼	<input type="radio"/>	<input type="radio"/>	<input type="radio"/>	<input type="radio"/>	<input type="radio"/>
18		All events ▼	<input type="radio"/>	<input type="radio"/>	<input type="radio"/>	<input type="radio"/>	<input type="radio"/>
19		All events ▼	<input type="radio"/>	<input type="radio"/>	<input type="radio"/>	<input type="radio"/>	<input type="radio"/>
20		All events ▼	<input type="radio"/>	<input type="radio"/>	<input type="radio"/>	<input type="radio"/>	<input type="radio"/>
			Essential	Essential ▼	Essential ▼	Essential ▼	Essential ▼
			5 Retry ▼	5 Retry ▼	5 Retry ▼	5 Retry ▼	5 Retry ▼

- **Reporting URL**

This is used for installer to program report destinations.

- 1 Climax CID protocol via IP**

Format: ip://(Account Number)@(server ip):(port)/CID

Example: ip://1234@54.183.182.247:8080/CID

- 2 SIA DC-09 protocol via IP**

Format: ip://(Account Number)@(server ip):(port)/SIA

Example: ip://1234@54.183.182.247:8080/SIA

- 3 SIA DC-09 protocol via IP with AES encryption**

Format: ip://(Account Number)@(server ip):(port)/SIA/KEY/(128,196 or 256 bits Key)

Example:

ip://1234@54.183.182.247:8080/SIA/KEY/ 4A46321737F890F654D632103F86B4F3

- 4 SIA DC-09 protocol using CID event code via IP**

Format: ip://(Account Number)@(server ip):(port)/CID_SIA

Example: ip://1234@54.183.182.247:8080/CID_SIA

- 5 SIA DC-09 protocol using CID event code via IP, with HEX encryption.**

Format: ip://(Account Number)@(server ip):(port)/CID_SIA/KEY/(HEX)

Example:

ip://1234@54.183.182.247:8080/CID_SIA/KEY/4A46321737F890F654D632103F86B4
F3

6 CSV protocol via IP

Format: ip://{Account Number}@(server ip):(port)/CSV

Example: ip://1234@54.183.182.247:8080/CSV

7 CSV protocol via IP including username and password

Format: ip://{Account Number}@(server ip):(port)/CSV/User/Password

Example: ip://1234@54.183.182.247:8080/CSV/abcd/1357

8 Email

Format: mailto:user@example.com

Example: mailto:john@gmail.com

- **Level**

Select a reporting condition:

All events: The system will report all events to this destination.

Alarm events: The system will only report alarm event to this destination.

Status events: The system will only report status event(non-alarm events) to this destination.

- **Group**

Select a group for your report destination The system will make report according to the following principle:

- ☞ Group with higher priority will be reported first: Ex: Group 1 → Group 2 → Group 3....
- ☞ If reporting to the first destination in a group fails, the system will move on to the next report destination in the group.
- ☞ If reporting to one of the report destinations in a group is successful, the system will consider reporting to this group successful and stop reporting to rest of the destinations in the group. It will then move on to report to the next group.
- ☞ If reporting to all destinations in a group fails, the system will retry report to group according to retry times set below. If reporting is still unsuccessful after retries, the system will move on to report the the next group according to Essential/Optional setting below.
- ☞ After completing a round of reporting (From Group 1 → Group 2 →Group5), If there is any group set as Essential which has not received report successfully, the system will restart the reporting cycle to retry reporting until every group set as Essential is reported successfully.

- **Essential/Optional**

Essential: the system will report to all groups set as **Essential**. The system will never give up trying to report to any group set as Essential until at least one of the destinations in every Essential group successfully receives the report. Group 1 is always set as **Essential** and cannot be changed.

Optional: The system will only report to group set as **Optional** when reporting to its previous group fails. For example: if Group 3 is set is optional, the Control Panel will only report to Group 3 if reporting to Group 2 fails.

- **1 Retry/ 3 Retry/ 5 Retry/ 10 Retry/ 99 Retry:**

If reporting to all destinations in a group fails, the system will retry reporting to the group according to the retries times set here.

<NOTE>

- When the panel is registered into Climax's Home Portal Server, URL1 will be filled in with Home Portal Server report information. Do not change the information once registration is complete or reporting to Home Portal Server may encounter error.
- After registering the panel in Home Portal Server, if you wish to set more reporting destination, the new report destination should be set to different group than URL1 otherwise it may not be able to receive report successfully.

8.5. Code Settings

The Duress Code, Master Code & Temporary Code adds the flexibility of different security level for operation in **Code Settings** menu.

Step 1. Key in your preferred 4-6 digit **Installer Code**, **Duress Code**, **Master Code**, and/or **Temporary Code**.

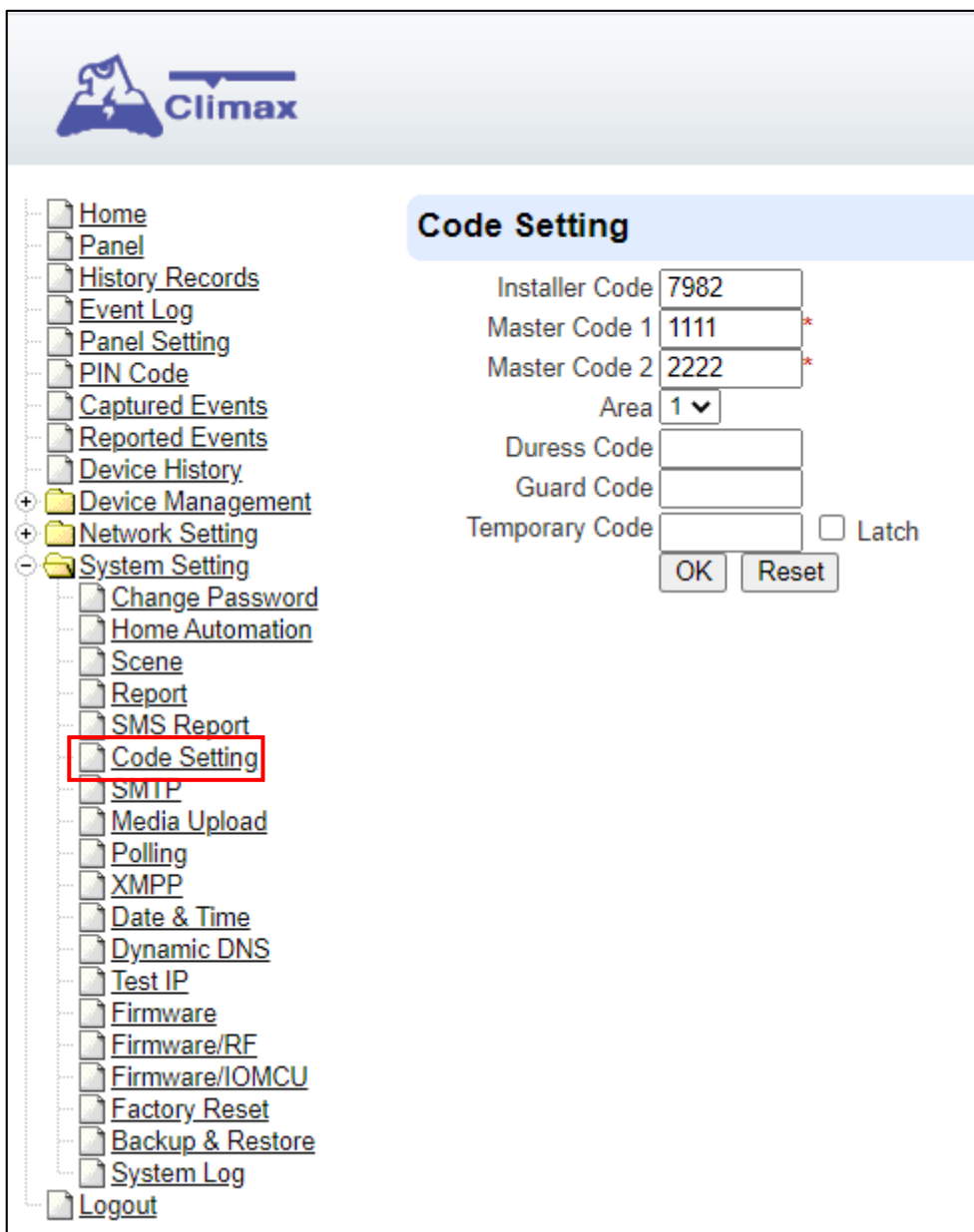

The screenshot displays the Climax web interface. On the left is a navigation tree with 'Code Setting' highlighted. The main panel, titled 'Code Setting', contains the following fields and controls:

- Installer Code: 7982
- Master Code 1: 1111*
- Master Code 2: 2222*
- Area: 1 (dropdown)
- Duress Code: (empty)
- Guard Code: (empty)
- Temporary Code: (empty) Latch
- Buttons: OK, Reset

Step 2. You can also choose to have Latch Option On / Off for Temporary Code by tick the Latch Option box and press **OK** to confirm the settings.

- **Installer Code**

The Installer Code is used for SMS Remote Programming, when sending a remote programming message, the user needs to enter Installer Code in the message to be able to program the system. The default Installer code is: **7982**.

- **Master Code**

The default Master Code for Area 1 and Area 2 are: 1111 and 2222 respectively.

- **Area**

Each Area has different Duress Code, Master Code, and Temporary Code. Select the Area

to program the code setting in this area.

- **Duress Code**

The Duress Code is designed for transmitting a secret & silence alarm.

When Duress Code is used for accessing the system, the Control Panel will report a secret alarm message without sounding the siren to the Central Monitoring Station to indicate of a **Duress Situation in Progress**.

The Duress Code consists of 4-6 digits and is not activated as default by the factory.

- **Guard Code**

The Guard Code is designed for security patrol personnel to arm/disarm the system. It can be set the same as a User PIN Code.

The Guard Code consists of 4-6 digits and is not activated as default by the factory.

- **Temporary Code**

Temporary Code is also used to arm/disarm the system, but it is for a temporary user. The temporary Code is **ONLY** valid for one-access per arming and disarming. Afterwards, the Temporary Code will be automatically erased and needs to be reset for a new Temporary user.

The Temporary Code consists of 4-6 digits and is not activated as default by the factory.

- **Latch Option**

This is to program the Latch Key Reporting feature for Temporary Code. Please click the box to select the options.

Latch → **Latch Report ON** = Whenever the system is armed, home/ day home/ night home armed or disarmed, the Panel will transmitt Contact ID code / SMS message / GPRS reporting (according to pre-setting) to notify the Central Monitoring Station.

Latch → **Latch Reprot OFF** = Whenever the system is armed, home/ day home/ night home armed or disarmed, the Panel will NOT transmit reporting(s) to notify the Central Monitoring Station.

- **Delete**

Except Master Code which can't be disabled in any way, Temporary and Duress Code can be disabled by cleaning the code box and leaving the box as blank.

8.6. SMTP Setting

Program the mail server related settings. The email account you set here would be used to send report for events or picture and video clip captured by PIR Camera and PIR Video Camera.

The screenshot shows the Climax web interface. On the left is a navigation tree with 'SMTP' highlighted in red. The main area is titled 'SMTP Setting' and contains the following fields and controls:

- Server:
- Port:
- User:
- Password:
- From:
- Using TLS/SSL encrypted channels (Secure SMTP)
- OK Reset

Below this is a 'Test E-Mail' section with:

- Receiver:
- OK Reset

Step 1. Enter the following settings:

- **Server:** set the mail server (max. 60 digits/alphabets).
- **Port:** set the port number (max. 5 digits/alphabets).
- **User:** set the mail account name (max. 30 digits/alphabets).
- **Password:** set the password corresponding to the mail account name (max. 30 digits/alphabets).
- **From:** set the email address according to your mail sever and account name. If your mail server supports other email address, you can enter the email address here. (max. 30 digits/alphabets).
- **Using TLS/SSL encrypted channels (Secure SMTP):** If your mail server uses TLS or SSL encryption method for secure transfer, please click the box to enable the setting

Step 2. Click **OK** to confirm the setting.

8.7. Media Upload

The system can deliver captured images and video clips captured by PIR Cameras and PIR Video Camera to cell phone, email or FTP.

The screenshot shows the Climax web interface. On the left is a navigation tree with 'Media Upload' selected. The main area is titled 'Media Upload' and contains the following configuration options:

- URL 1:
- URL 2:
- URL 3:
- URL 4:
- URL 5:
- Prefix:
- Delete events after uploaded.

Note:

1. Upload via IP (Ethernet or GPRS) in FTP protocol, ex: ftp://user:password@server/path
2. Upload via IP (Ethernet or GPRS) in HTTP protocol, ex: http://server/path
3. Mail via IP (Ethernet or GPRS), ex: mailto: user@server
4. Manitou via IP (Ethernet or GPRS), ex: manitou://user@server:port
5. Send MMS e-mail via GPRS, ex: mms: user@mail.server
6. Send MMS via GPRS, ex: mms: telephone

Buttons:

- **FTP:** <ftp://user.password@server/path>
- **HTTP:** <http://ip:port/path>
- **Email:** <mailto:user@server> (transmitting an alarm image over Ethernet)
- **Manitou:** <manitou://user@server:port>
- **MMS via Telephone:** mms: telephone number
- **MMS via GPRS:** mms: [user@mail.server](mms://user@mail.server) (transmitting an alarm image over MMS)

<NOTE>

- If “Deleted events after uploaded” is checked, the system will automatically clear all captured images which are displayed in the Captured Events menu after it successfully sends out those captured images to preset reporting destinations.

8.8. Polling

The polling function enables the Control Panel to query the destination you set (URL1 or URL2) in turn as to whether it has any data to transmit.

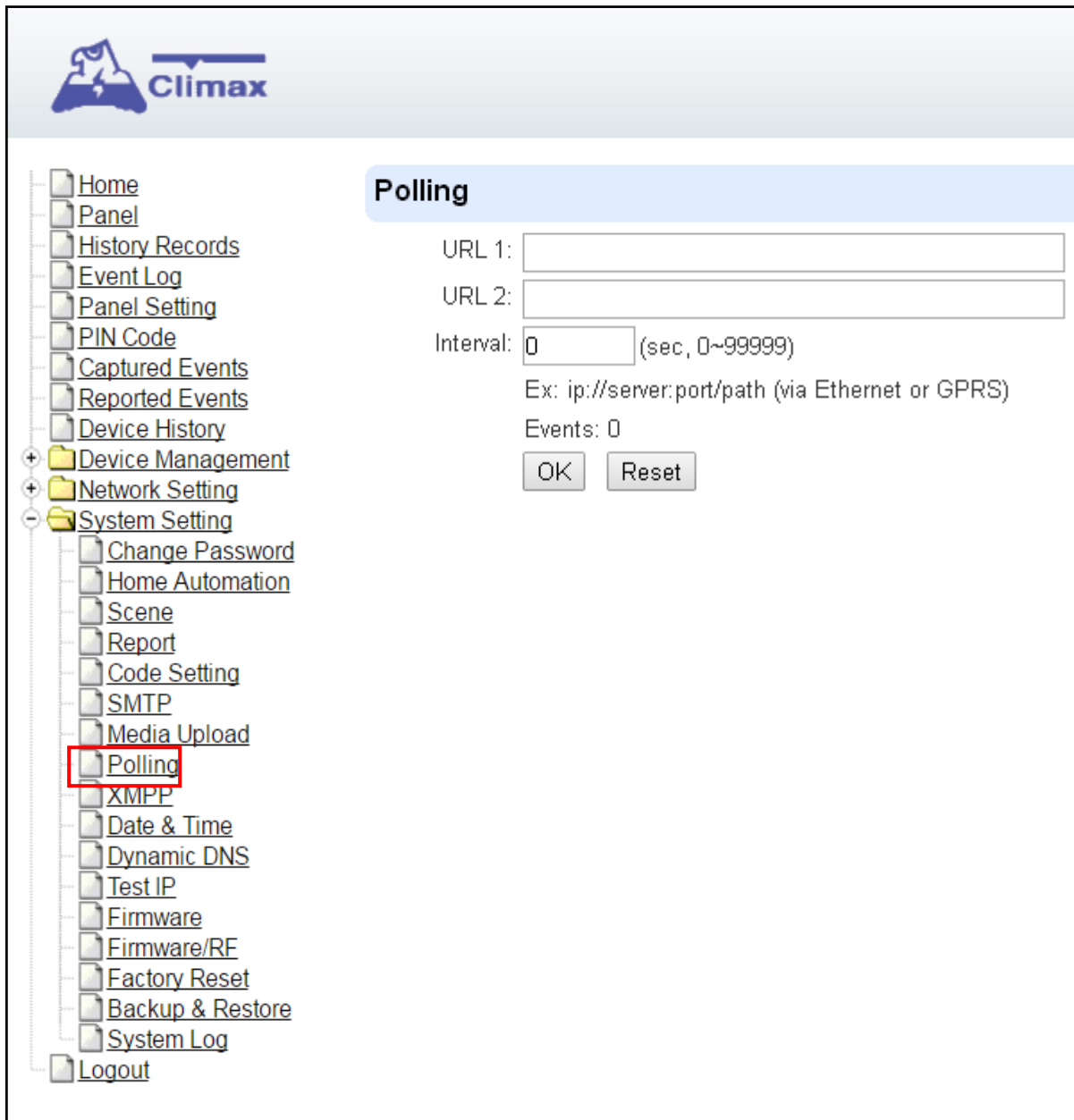

The screenshot shows the Climax web interface. On the left is a navigation menu with the following items: Home, Panel, History Records, Event Log, Panel Setting, PIN Code, Captured Events, Reported Events, Device History, Device Management, Network Setting, System Setting, Change Password, Home Automation, Scene, Report, Code Setting, SMTP, Media Upload, Polling (highlighted with a red box), XMPP, Date & Time, Dynamic DNS, Test IP, Firmware, Firmware/RF, Factory Reset, Backup & Restore, System Log, and Logout. The main content area is titled "Polling" and contains the following fields and controls:

- URL 1:
- URL 2:
- Interval: (sec, 0~99999)
- Ex: ip://server:port/path (via Ethernet or GPRS)
- Events: 0
- OK
- Reset

- **URL/URL2:** ip://server:port/path
- **Interval :** interval time of polling

8.9. XMPP

XMPP setting enables the Control Panel to query the set destination. This setting is required for the Control Panel to connect to Climax's Home Portal Server for remote control. If the panel is disconnected from the server, it will retry connection every 3 minutes.

The screenshot shows the Climax control panel interface. On the left is a navigation tree with 'XMPP' selected. The main area is titled 'XMPP' and contains the following settings:

- Server: tw.vestasmarthome.com
- Backup Server: (empty)
- Port: 5222
- User: (empty)
- Password: (empty)
- Domain: climax-home-portal
- Buddy List: security_admin
- Ping Interval: 40 sec
- Connected. Events: 0
- Buttons: OK, Reset

- **Server: server address** (dependent upon default firmware)
 - US server: us.vestasmarthome.com
 - EU server: eu.vestasmarthome.com
 - Taiwan server: tw.vestasmarthome.com
- **Port:** server's port number
- **User:** authorized user account name
- **Password:** authorized user password
- **Domain:** domain address
- **Buddy List:** contact destination
- **Ping Interval:** server connection test interval

8.10. Date & Time

Program the current **Date & Time** and set automatic synchronization with internet time server.

The screenshot shows the Climax web interface. On the left is a navigation menu with the following items: Home, Panel, History Records, Event Log, Panel Setting, PIN Code, Captured Events, Reported Events, Device History, Device Management, Network Setting, System Setting (highlighted), Change Password, Home Automation, Scene, Report, Code Setting, SMTP, Media Upload, Polling, XMPP, Date & Time (highlighted with a red box), Dynamic DNS, Test IP, Firmware, Firmware/RF, Factory Reset, Backup & Restore, System Log, and Logout. The main content area is divided into three sections: **Date & Time**, **Time Zone**, and **Internet Time**. In the **Date & Time** section, the Date is set to 2014/05/08 and the Time is 11:43. In the **Time Zone** section, the Time Zone is set to (GMT+00:00) Greenwich Mean Time: Dublin, Edinburgh, Lisbon, London. In the **Internet Time** section, the checkbox for 'Automatically synchronize with an Internet time server.' is unchecked, and the Server is set to pool.ntp.org. The footer of the page contains the copyright notice: ©2014 Climax Tech. Co., Ltd.

- **Date & Time:** set current month, date and time.
- **Time Zone:** choose your time zone, and then the system will calculate the daylight saving time automatically (if necessary).
- **Internet Time:** the system will automatically synchronize with an internet time server. Tick the check box to enable this function. Available options: time1.google.com, pool.ntp.org, time.nist.gov and tick.usno.navy.mil.

8.11. Dynamic DNS

This page is used to provide you the Control Panel's current public IP address.

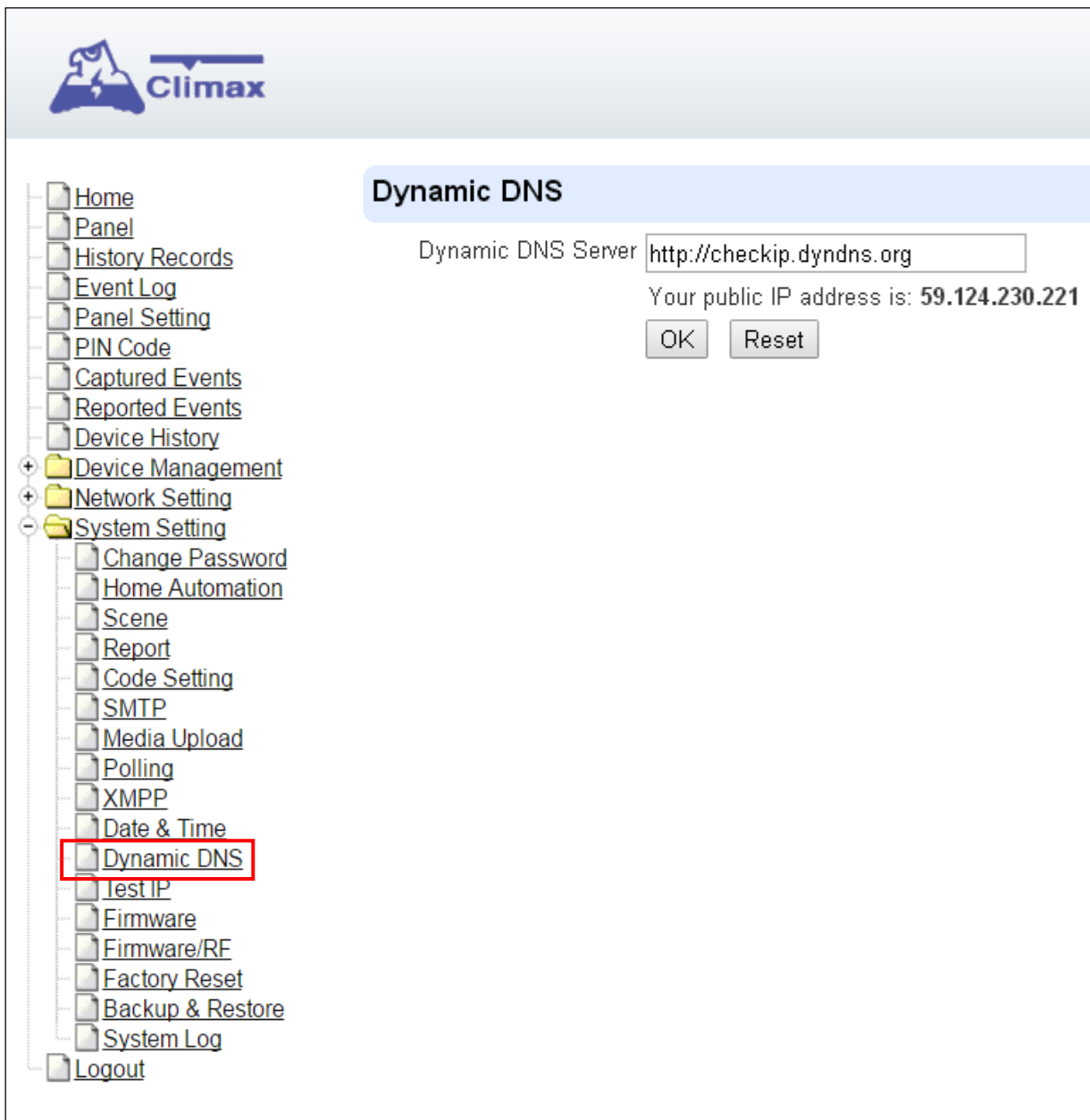

The screenshot shows the Climax Control Panel interface. On the left is a navigation tree with the following items: Home, Panel, History Records, Event Log, Panel Setting, PIN Code, Captured Events, Reported Events, Device History, Device Management, Network Setting, System Setting (expanded), Change Password, Home Automation, Scene, Report, Code Setting, SMTP, Media Upload, Polling, XMPP, Date & Time, Dynamic DNS (highlighted with a red box), Test IP, Firmware, Firmware/RF, Factory Reset, Backup & Restore, System Log, and Logout. The main content area is titled "Dynamic DNS" and contains the following information: "Dynamic DNS Server" with a text input field containing "http://checkip.dyndns.org", "Your public IP address is: 59.124.230.221", and two buttons labeled "OK" and "Reset".

- **Dynamic DNS Server:** <http://checkip.dyndns.org>

8.12. Test IP

This is for you to test the Control Panel internet connection.

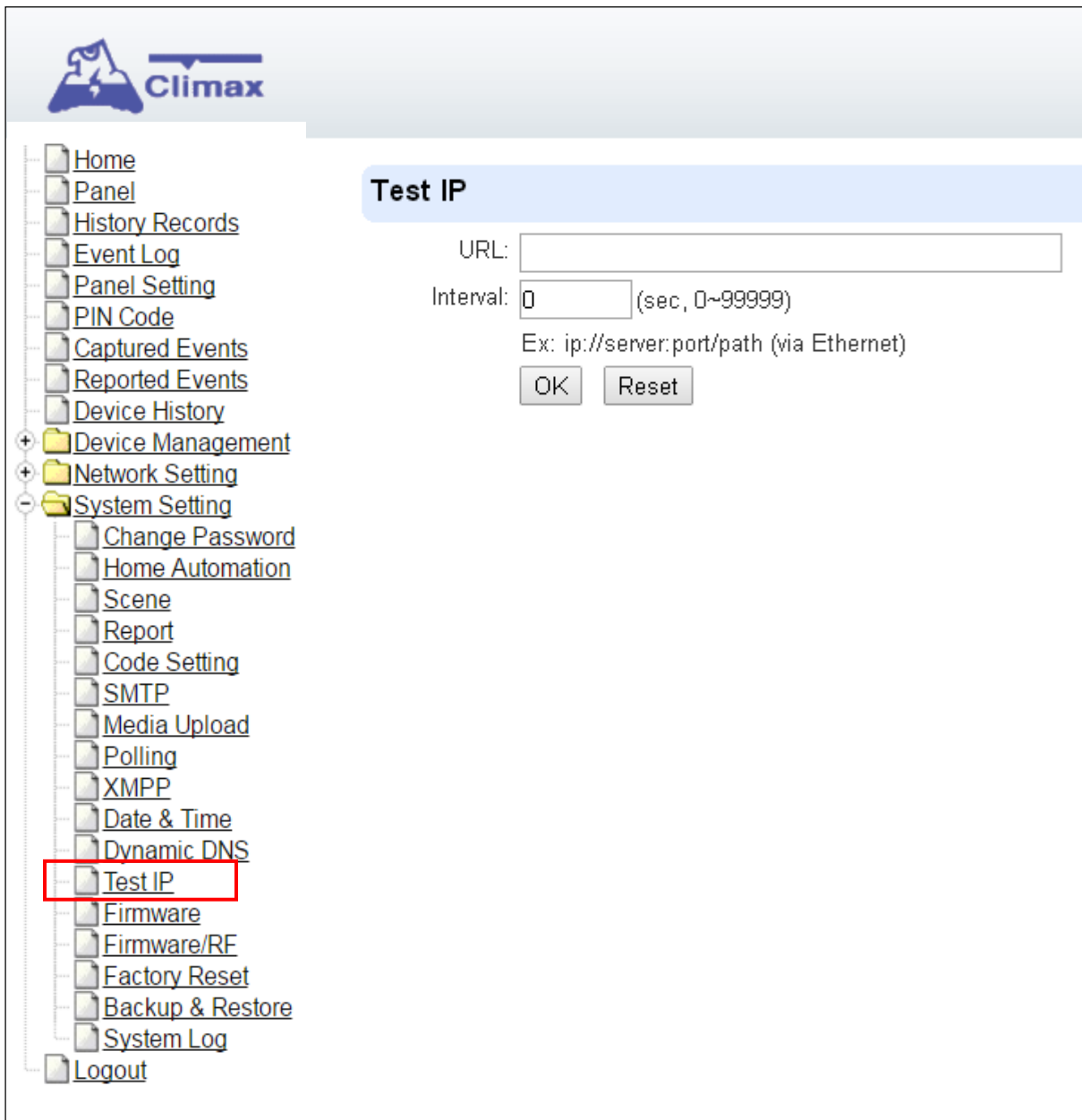

The screenshot shows the Climax Control Panel interface. On the left is a navigation tree with the following items: Home, Panel, History Records, Event Log, Panel Setting, PIN Code, Captured Events, Reported Events, Device History, Device Management, Network Setting, System Setting, Change Password, Home Automation, Scene, Report, Code Setting, SMTP, Media Upload, Polling, XMPP, Date & Time, Dynamic DNS, Test IP (highlighted with a red box), Firmware, Firmware/RF, Factory Reset, Backup & Restore, System Log, and Logout. The main content area is titled "Test IP" and contains the following fields and buttons:

- URL:
- Interval: (sec, 0~99999)
- Ex: ip://server:port/path (via Ethernet)
- OK
- Reset

Step 1. Enter the URL destination you want to test connection to.

Step 2. Enter the test interval.

Step 3. Click "OK"

You can check the test connect result in **System Log**.

8.13 Firmware Upgrade

You can update the firmware via this web page.

Step 1. Click on “**Choose File**” and locate the latest firmware file in your PC.



The screenshot shows the Climax web interface for the Firmware Upgrade page. On the left is a navigation menu with various settings options. The 'Firmware' option is highlighted with a red box. The main content area is titled 'Firmware Upgrade' and contains the following text:

Firmware Upgrade

This page applies a firmware update to your alarm panel. You should only apply updates with the correct firmware.

Your current firmware version is: GL 0.0.2.23

Firmware File: 未選擇任何檔案

To locate the correct file, click on the browse file button and find the directory you downloaded it to. Click on the file and then OK. When the filename appears in the box, click the apply button. DO NOT interrupt the update process.

© 2011-2020 Climax Tech. Co., Ltd.

Step 2. Press “**Apply**” to upload the latest firmware to Control Panel

Step 3. Wait for 1 min and do NOT power off during this time.

Step 4. Once Firmware upgrading is complete, the Control Panel will reboot automatically

8.14. RF Firmware Upgrade

You can update the Control Panel's RF firmware via this web page.

Step 1. Click on “**Choose File**” and locate the latest firmware file (“**unzipped image.bin**” file) in your PC.



The screenshot shows the Climax web interface for the RF Firmware Upgrade page. On the left is a navigation menu with items like Home, Panel, History Records, Event Log, Panel Setting, PIN Code, Captured Events, Reported Events, Device History, Device Management, Network Setting, System Setting, Change Password, Home Automation, Scene, Report, SMS Report, Code Setting, SMTP, Media Upload, Polling, XMPP, Date & Time, Dynamic DNS, Test IP, Firmware, **Firmware/RF** (highlighted with a red box), Firmware/OMCU, Factory Reset, Backup & Restore, System Log, and Logout. The main content area is titled "RF Firmware Upgrade" and contains the following text: "This page applies a firmware for RF update to your alarm panel. You should only apply updates with the correct firmware." "Your current firmware version is: BG_U-ITR-F1-BD_BL.A30.20190726" "Firmware File: 未選擇任何檔案" "To locate the correct file, click on the browse file button and find the directory you downloaded it to. Click on the file and then OK. When the filename appears in the box, click the apply button. DO NOT interrupt the update process." Below this text is an "Apply" button. The footer of the page reads "© 2011-2020 Climax Tech. Co., Ltd."

Step 2. Press “**Apply**” to upload the latest firmware to Control Panel

Step 3. Wait for 1 min and do NOT power off during this time.

Step 4. Once Firmware upgrading is complete, the Control Panel will reboot automatically

8.15. IO MCU Firmware Upgrade

Step 1. Click “Firmware/IOMCU” to enter this page.

Step 2. Click on “Choose File” and locate the latest firmware file in your PC.

The screenshot displays the Climax web interface for the IO MCU Firmware Upgrade process. On the left, a navigation menu lists various system settings, with 'Firmware/IOMCU' highlighted in red. The main content area is titled 'IO MCU Firmware Upgrade' and contains the following text: 'This page applies a firmware for IO MCU update to your alarm panel. You should only apply updates with the correct firmware.' Below this, it states 'Your current firmware version is: U-IO_BL.A01.2020.04.10'. A 'Firmware File:' field is present with a '選擇檔案' (Choose File) button and the text '未選擇任何檔案' (No file selected). An 'Apply' button is located below the file field. A copyright notice '© 2011-2020 Climax Tech. Co., Ltd.' is visible in the bottom right corner of the interface.

Step 3. Press “Apply” to upload the latest firmware to Control Panel

Step 4. Wait for 1 min and DO NOT power off during this time.

Step 5. Once Firmware upgrading is complete, the Panel will reboot automatically.

8.16. Factory Reset

You can clear all programmed parameters in the Control Panel and reset it to Factory Default.

Once the **Factory Reset** is executed, all the programmed settings will be returned to their default values, and all the learnt-in devices will be removed. You will need to restart the programming and learning process again.

8.16.1 Remote Reset

Step 1. Tick the **Kept current network setting** to keep the current Network settings. Otherwise, the system will reset its value back to factory default. Tick the **Kept current device list** box to keep the current learnt-in devices. Otherwise, the system will reset its value back to factory default.

Step 2. Press **Yes** to continue the Reset procedure.

Step 3. Wait for 1 min and do NOT power off during this time.

Step 4. Once reset is complete, it will automatically reboot the main unit.

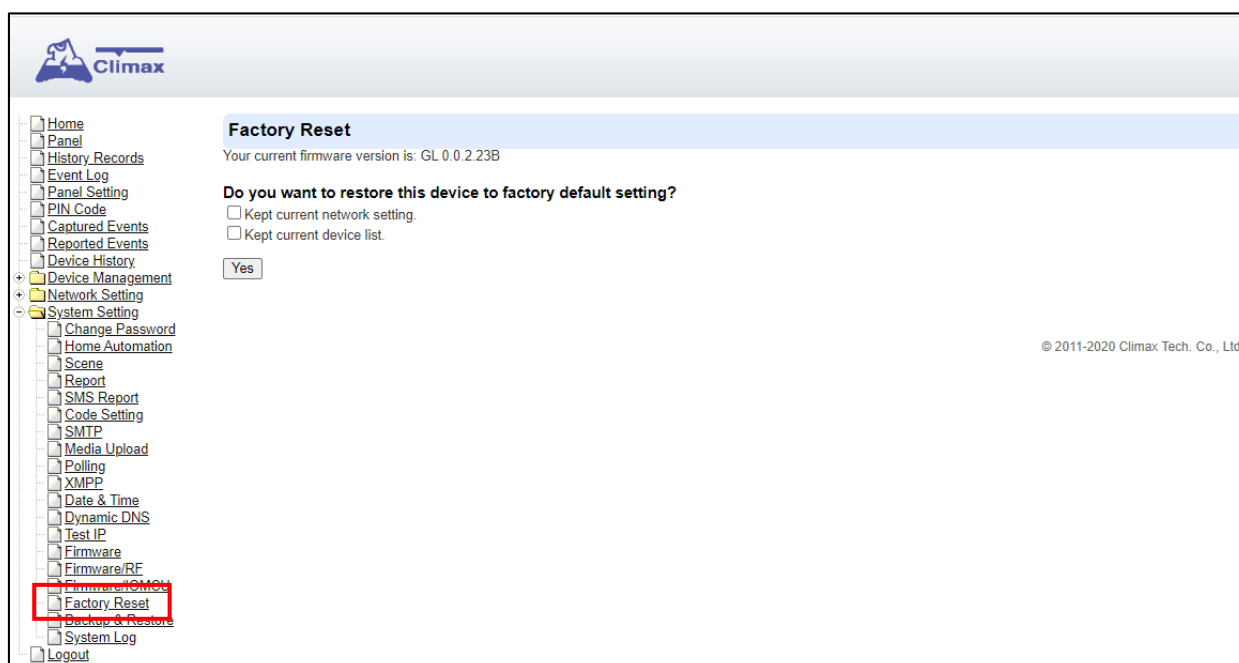

8.16.2 Local Reset

Step 1. Slide battery switch to OFF.

Step 2. Press and hold the learn button.

Step 3. Keep holding the reset button until you hear continuous beeps. The 3 LEDs will flash 3 times.

Step 4. Release the button and wait for the Control Panel to reboot.

8.17. Backup & Restore

You can back up all programmed parameters and save these programmed values into a file. Besides, you also can restore pre-programmed settings.

8.17.1 Backup Data

Click **Download**, and you can back up all programmed data and save these programmed values into a file.

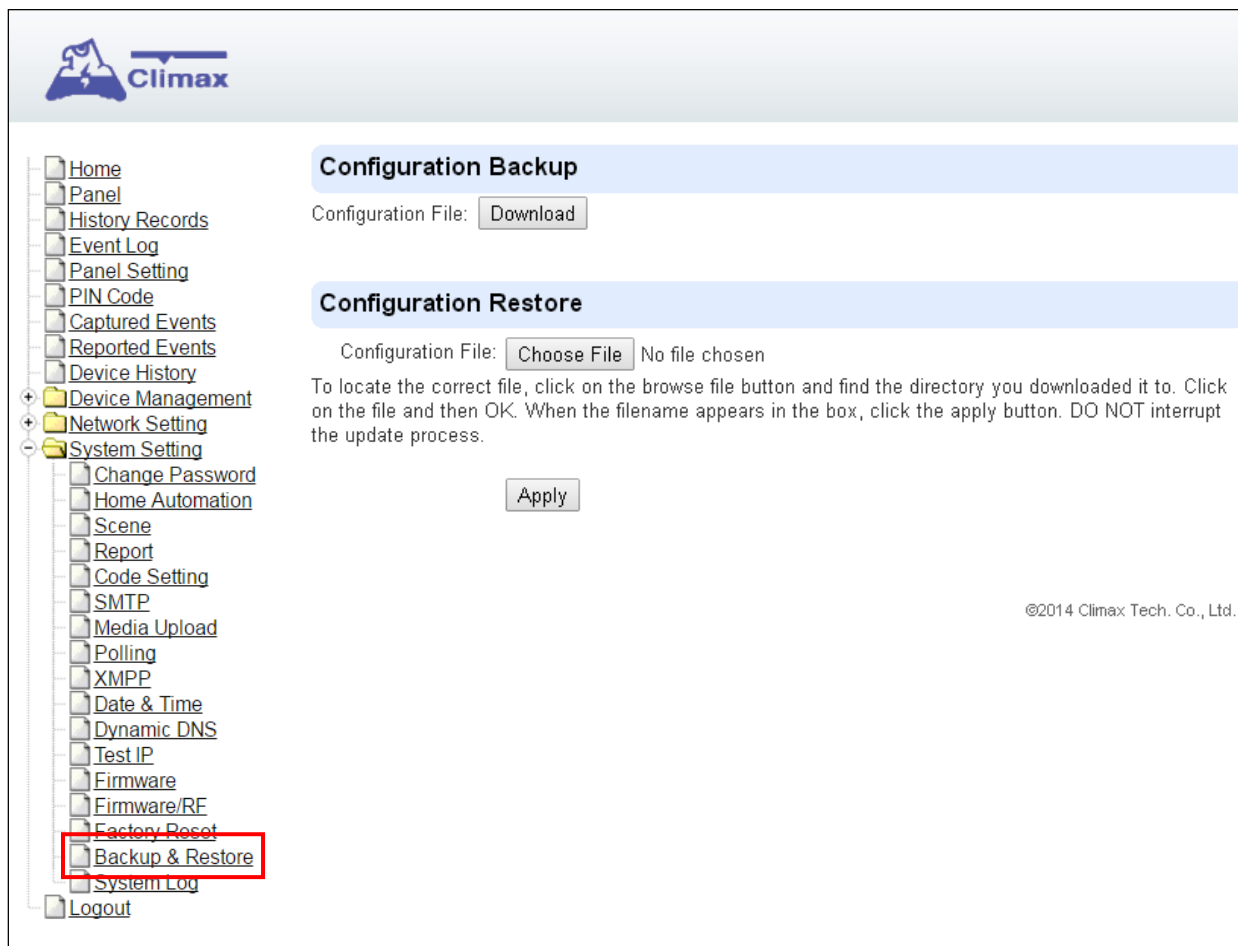

The screenshot displays the Climax web interface. On the left is a navigation tree with the following items: Home, Panel, History Records, Event Log, Panel Setting, PIN Code, Captured Events, Reported Events, Device History, Device Management, Network Setting, System Setting (expanded), Change Password, Home Automation, Scene, Report, Code Setting, SMTP, Media Upload, Polling, XMPP, Date & Time, Dynamic DNS, Test IP, Firmware, Firmware/RF, Factory Reset, Backup & Restore (highlighted with a red box), System Log, and Logout. The main content area has two sections: 'Configuration Backup' with a 'Download' button, and 'Configuration Restore' with a 'Choose File' button and the text 'No file chosen'. Below the 'Choose File' button is an 'Apply' button. A paragraph of instructions follows: 'To locate the correct file, click on the browse file button and find the directory you downloaded it to. Click on the file and then OK. When the filename appears in the box, click the apply button. DO NOT interrupt the update process.' The copyright notice '©2014 Climax Tech. Co., Ltd.' is located in the bottom right corner.

8.17.2 Restore Settings

Step 1. Click **Choose File**, select a saved file.

Step 2. Click **Apply** to apply the pre-programmed values to the main unit.

8.18. System Log

The system log webpage logs the control panel's detail system operation history.

The screenshot shows the Climax System Log interface. On the left is a navigation menu with options like Home, Panel, History, Records, Events Log, Panel Setting, PIN Code, Connected Events, Recorded Events, Device History, Device Management, System Setting, System Parameters, Home Automation, Scene, Report, SMS Report, Code Setting, SMTP, Media Upload, Polling, Z-Wave, Date & Time, Dynamic DNS, Test IP, Firmware, Firmware/CMCU, Factory Reset, Backup & Restore, System Log, and Logout. The main area displays a table of system log entries.

Time	Priority	Class	Action	Source	Message
2020/07/03 02:52:32	6	8	Success	Reporter	url=ip://127037858776@tv.vestasmarthome.com:8765/CID_SIA/SES/ret=0,reason="" event=311, text=Area 0 Zone 0 Panel Battery Missing/Dead
2020/07/03 02:51:41	6	30	Success	Worker	SMTP Setup Time
2020/07/03 02:51:34	6	26	Z-Wave	Z-Wave	Connected
2020/07/03 02:51:33	6	8	Success	Reporter	url=ip://127037858776@tv.vestasmarthome.com:8765/CID_SIA/SES/ret=0,reason="" event=383, text=Area 1 Zone 5 Tamper Restore
2020/07/03 02:51:33	6	8	Success	Reporter	url=ip://127037858776@tv.vestasmarthome.com:8765/CID_SIA/SES/ret=0,reason="" event=383, text=Area 1 Zone 5 Tamper
2020/07/03 02:51:30	6	8	Success	Reporter	url=ip://127037858776@tv.vestasmarthome.com:8765/CID_SIA/SES/ret=0,reason="" event=137, text=Area 0 Zone 0 Panel Tamper
2020/07/03 02:51:30	6	30	Wireless LAN	Worker	Setup Network Address
2020/07/03 02:51:29	6	30	Net	Worker	Plugged
2020/07/03 02:51:25	6	30	Net	Worker	Setup Network Address
2020/07/03 02:51:25	5	23	Initialize	VFA	Module Not Exist
2020/07/03 02:51:25	5	2	Initialize	ZigBee	Module Not Exist
2020/07/02 09:21:05	6	8	Success	Reporter	url=ip://127037858776@tv.vestasmarthome.com:8765/CID_SIA/SES/ret=0,reason="" event=311, text=Area 0 Zone 0 Panel Battery Missing/Dead
2020/07/02 09:20:15	6	30	Success	Worker	SMTP Setup Time
2020/07/02 09:20:06	6	26	Z-Wave	Z-Wave	Connected
2020/07/02 09:20:05	6	8	Success	Reporter	url=ip://127037858776@tv.vestasmarthome.com:8765/CID_SIA/SES/ret=0,reason="" event=383, text=Area 1 Zone 5 Tamper Restore
2020/07/02 09:20:02	6	8	Success	Reporter	url=ip://127037858776@tv.vestasmarthome.com:8765/CID_SIA/SES/ret=0,reason="" event=383, text=Area 1 Zone 5 Tamper
2020/07/02 09:20:02	6	8	Success	Reporter	Setup Network Address
2020/07/02 09:20:01	6	30	Net	Worker	url=ip://127037858776@tv.vestasmarthome.com:8765/CID_SIA/SES/ret=0,reason="" event=137, text=Area 0 Zone 0 Panel Tamper
2020/07/02 09:19:57	6	30	Net	Worker	Plugged
					Setup Network Address

Limit # of items:

System Log File:

© 2011-2020 Climax Tech. Co., Ltd.

- **System Log File Download:** Click to download a detail log files into your computer for more information.

9. Event & History

This section introduces event history of the system.

9.1. Captured Events

This page stores all captured pictures and videos by PIR Camera and PIR Video Camera. When a PIR Camera is triggered, it will take 3 pictures in quick succession, when a PIR Video Camera is triggered, it will take a 10-second video clip. You can also request the PIR Camera to take a picture and PIR Video Camera to take a 10-second video clip manually.

Captured events will be displayed in this page with their information for you to view. Simply click on the picture or video to view them. You can also click **Delete** to delete the event.

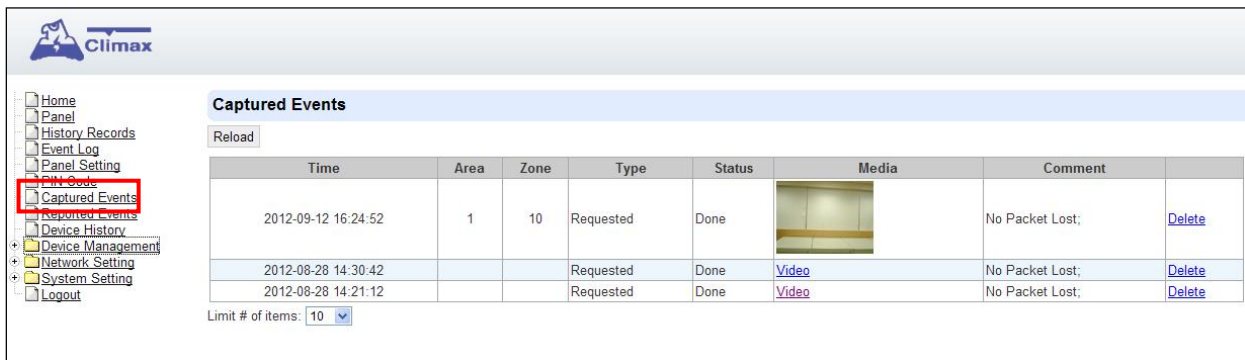

The screenshot shows the Climax web interface. On the left is a navigation menu with items: Home, Panel, History Records, Event Log, Panel Setting, PIN Code, **Captured Events** (highlighted with a red box), Reported Events, Device History, Device Management, Network Setting, System Setting, and Logout. The main content area is titled 'Captured Events' and features a 'Reload' button. Below the title is a table with the following data:

Time	Area	Zone	Type	Status	Media	Comment	
2012-09-12 16:24:52	1	10	Requested	Done		No Packet Lost;	Delete
2012-08-28 14:30:42			Requested	Done	Video	No Packet Lost;	Delete
2012-08-28 14:21:12			Requested	Done	Video	No Packet Lost;	Delete

At the bottom of the table, there is a 'Limit # of items:' dropdown menu set to '10'.

- **Reload** : Click to refresh the page content
- **Limit # of Items**: Click the drop down menu on the page to select the numbers of captured events you want to display.

9.2. Reported Events

This page stores all triggered events by the control panel by recording the events' CID event code and report status.

Reported Events

Reload

Time	Area	Zone / User	Trigger / Restore	CID event	Message	Report Status	Comment
2012-09-12 15:09:37	1	6	Trigger	383	Tamper	Done	
2012-09-12 14:49:33	1	5	Trigger	383	Tamper	Done	
2012-09-12 14:49:27	1	5	Restore	383	Tamper Restore	Done	
2012-09-12 14:48:57	1	5	Trigger	383	Tamper	Done	
2012-09-12 14:48:56	1	5	Restore	383	Tamper Restore	Done	
2012-09-12 14:48:51	1	5	Trigger	383	Tamper	Done	
2012-09-12 14:48:49	1	5	Restore	383	Tamper Restore	Done	
2012-09-12 14:45:07	1	5	Trigger	383	Tamper	Done	
2012-09-12 14:45:05	1	5	Restore	383	Tamper Restore	Done	
2012-09-12 14:43:29	1	5	Trigger	383	Tamper	Done	
2012-09-12 14:43:27	1	5	Restore	383	Tamper Restore	Done	
2012-09-12 14:42:46	1	5	Trigger	383	Tamper	Done	
2012-09-12 04:04:16	1	1	Trigger	147	Supervision Failure	Done	
2012-09-12 04:04:16	1	3	Trigger	147	Supervision Failure	Done	
2012-09-12 04:04:15	1	2	Trigger	147	Supervision Failure	Done	
2012-09-11 16:35:18	0	0	Trigger	311	Panel Battery Missing/Dead	Done	
2012-09-11 16:04:16	0	0	Trigger	137	Panel Tamper	Done	
2012-09-11 10:40:58	0	0	Trigger	311	Panel Battery Missing/Dead	Done	
2012-09-11 10:16:07	0	0	Trigger	137	Panel Tamper	Done	
2012-08-28 19:18:02	1	1	Trigger	383	Tamper	Done	

Limit # of items: 20

- **Reload** : Click to refresh the page content
- **Limit # of Items**: Click the drop down menu on the page to select the numbers of captured events you want to display.

9.3. Event Log

The Event Log page records specific actions performed by the Control Panel and accessory devices.

The screenshot shows the Climax web interface. On the left is a navigation menu with items like Home, Panel, History Records, Event Log (highlighted), Panel Setting, PIN Code, Captured Events, Reported Events, Device History, Device Management, Network Setting, System Setting, and Logout. The main area features a 'Reload' button and a table of event logs. The table has columns for Time, Area, Mode, Action, User, Source, Device Type, and Message. Below the table is a 'Limit # of items' dropdown menu set to 20.

Time	Area	Mode	Action	User	Source	Device Type	Message
2015/01/12 05:26:09			Switch To Standard Mode		Panel		Web
2015/01/12 05:25:35	1		Device Added		Zone4	IP Camera	Web
2015/01/12 05:25:04			Switch To Learn Mode		Panel		Web
2015/01/12 05:25:03			Switch To Standard Mode		Panel		Web
2015/01/12 05:23:49			Switch To Learn Mode		Panel		Web
2015/01/12 04:09:49			Switch To Standard Mode		Panel		Web
2015/01/12 04:08:20			System Fault		Panel		Area1Zone1 Tamper; Area1Zone3 Tamper
2015/01/12 04:08:20	1	Disarm	Device Tamper		Zone3	IR Camera	Trigger
2015/01/12 04:04:48			Switch To Learn Mode		Panel		Web
2015/01/12 04:04:45			Switch To Standard Mode		Panel		Web
2015/01/12 04:03:31	1		Device Added		Zone3	IR Camera	Web
2015/01/12 04:02:32	1		Device Added		Zone2	Dimmer	Web
2015/01/12 04:01:38			Switch To Learn Mode		Panel		Web
2015/01/12 03:41:13			System Fault		Panel		Area1Zone1 Tamper
2015/01/12 03:41:12	1	Disarm	Ignored		Zone1	Door Contact	Tamper Ignored
2015/01/12 03:41:12	1	Disarm	Device Tamper		Zone1	Door Contact	Trigger
			System Fault		Panel		Restore
			System Fault		Panel		Network Cable Unplugged; ZigBee Not Ready
			Initialize		Panel		Ready
2015/01/12 03:16:07			System Fault		Panel		Area1Zone1 Tamper

Limit # of items: 20 ▼

- **Reload** : Click to refresh the page content
- **Limit # of Items**: Click the drop down menu on the pageto select the numbers of captured events you want to display.

9.4. Device History

You can track your accessory device status history under **Device History**. For Power Switch Meter or Temperature Sensor, the update history power consumption or temperature reading will be displayed under this page (the current info is also displayed under **Panel** and **PSS Control**).

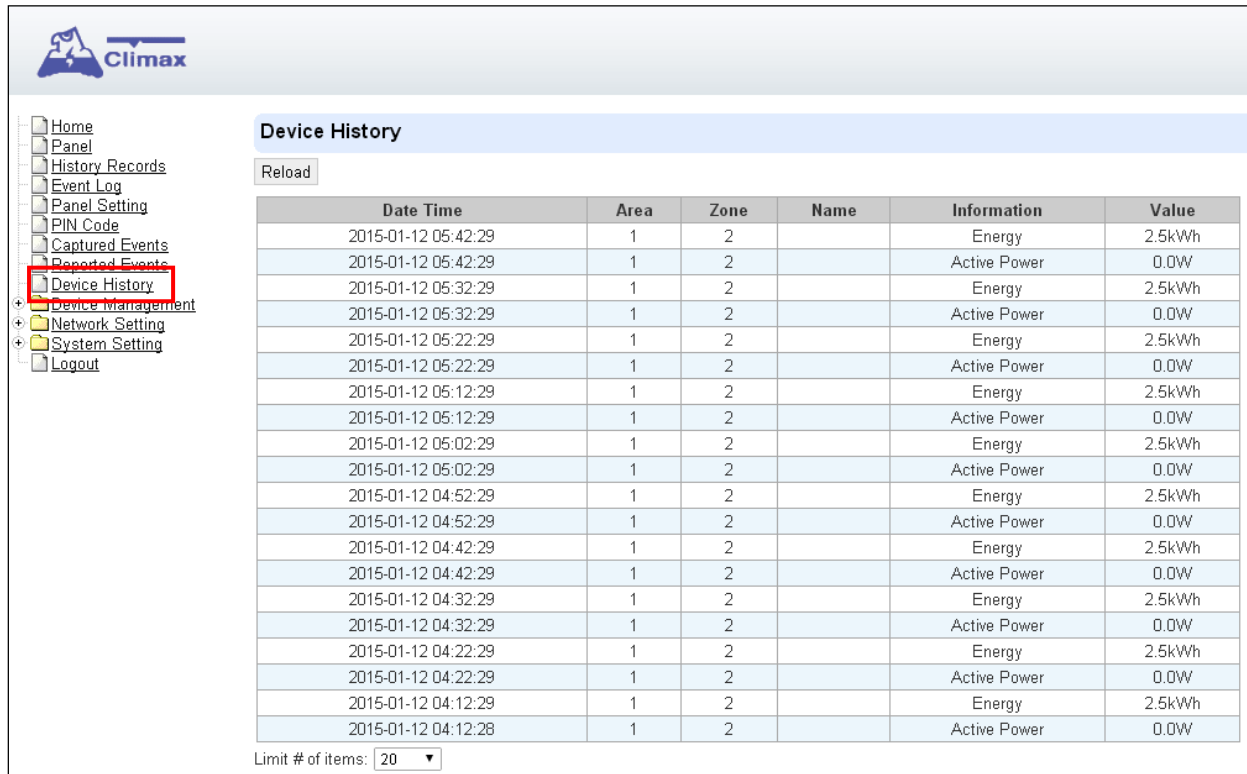

The screenshot displays the Climax web interface. On the left is a sidebar menu with items: Home, Panel, History Records, Event Log, Panel Setting, PIN Code, Captured Events, Reported Events, Device History (highlighted with a red box), Device Management, Network Setting, System Setting, and Logout. The main content area is titled 'Device History' and features a 'Reload' button. Below the button is a table with the following data:

Date Time	Area	Zone	Name	Information	Value
2015-01-12 05:42:29	1	2		Energy	2.5kWh
2015-01-12 05:42:29	1	2		Active Power	0.0W
2015-01-12 05:32:29	1	2		Energy	2.5kWh
2015-01-12 05:32:29	1	2		Active Power	0.0W
2015-01-12 05:22:29	1	2		Energy	2.5kWh
2015-01-12 05:22:29	1	2		Active Power	0.0W
2015-01-12 05:12:29	1	2		Energy	2.5kWh
2015-01-12 05:12:29	1	2		Active Power	0.0W
2015-01-12 05:02:29	1	2		Energy	2.5kWh
2015-01-12 05:02:29	1	2		Active Power	0.0W
2015-01-12 04:52:29	1	2		Energy	2.5kWh
2015-01-12 04:52:29	1	2		Active Power	0.0W
2015-01-12 04:42:29	1	2		Energy	2.5kWh
2015-01-12 04:42:29	1	2		Active Power	0.0W
2015-01-12 04:32:29	1	2		Energy	2.5kWh
2015-01-12 04:32:29	1	2		Active Power	0.0W
2015-01-12 04:22:29	1	2		Energy	2.5kWh
2015-01-12 04:22:29	1	2		Active Power	0.0W
2015-01-12 04:12:29	1	2		Energy	2.5kWh
2015-01-12 04:12:28	1	2		Active Power	0.0W

At the bottom of the table, there is a 'Limit # of items:' label followed by a dropdown menu currently set to '20'.

- **Reload** : Click to refresh the page content
- **Limit # of Items**: Click the drop down menu on the pageto select the numbers of captured events you want to display.

10. Appendix

10.1. Fault Event Description

During operation, when the panel detects faulty events, the panel will log the event and make reports. When fault events exist in the system, the panel Fault LED will light up and the panel will emit a beep every 30 seconds.

- **Fault Event Table**

Fault Event	Descriptions
Panel AC Failure	The Control Panel's AC power is disconnected When AC failure is detected, the panel will turn off both Ethernet and mobile network functions when idle to conserve power. Ethernet and mobile network will be activated temporarily when an event is detected by the panel (i.e. alarm trigger) to send report, and will turn off again after finishing report. Accessing the panel via remote server XMPP connection is disabled during AC failure.
Panel Low Battery	The panel's backup battery is only used when AC failure is detected. When the backup battery voltage is low, the panel low battery event is generated
Panel Tamper	The tamper switch on back of the panel is not compressed against the back cover. This means the panel's cover is opened and not properly sealed.
Battery Dead/Missing	The panel cannot detect backup battery, this means the battery is either dysfunctional, or the battery switch is not slid to ON position.
Interference/Jamming	The panel detects radio frequency jamming, which will affect its ability to receive signal from RF devices
Device Low Battery	The accessory device at indicated zone number is low on battery
Device AC Failure	The accessory device at indicated zone number does not have AC power connection.
Device Tamper	The tamper switch of the device at indicated zone number is open
Device Supervision Failure	The panel was unable to receive supervision signal sent from accessory device at indicated zone number for the duration of Supervision Timer programmed. (i.e. If Supervision Timer is set to 12 hours, the panel will generate supervision failure event after failing to receive supervision signal for 12 hours)

10.2. Control Panel Mode and Response Table

For Alarm Activation by Events and Control Panel Responses, please refer to the following table:

Attribute	System Mode / Status					
	Disarm	Full Arm	Home Arm	Under Exit Timer	Under Exit Timer (No Response)	Under Entry Timer
No Response	No Response	No Response	No Response	Instant Burglar Alarm	No Response	No Response
Start Entry Delay 1	Instant Burglar Alarm (Interior)	Start Entry 1 → Burglar Alarm (Perimeter)	Start Entry 1 → Burglar Alarm (Interior)	Instant Burglar Alarm	No Response	Delayed Burglar Alarm
Start Entry Delay 2	Instant Burglar Alarm (Interior)	Start Entry 2 → Burglar Alarm (Perimeter)	Start Entry 2 → Burglar Alarm (Interior)	Instant Burglar Alarm	No Response	Delayed Burglar Alarm
Chime	Door Chime	Door Chime	Door Chime	Instant Burglar Alarm	No Response	Door Chime
Burglar Follow	Instant Burglar Alarm	Instant Burglar Alarm	Instant Burglar Alarm	Instant Burglar Alarm	No Response	Delayed Burglar Alarm
Burglar Instant	Instant Burglar Alarm	Instant Burglar Alarm	Instant Burglar Alarm	Instant Burglar Alarm	No Response	Instant Burglar Alarm
Burglar Outdoor	Instant Burglar Outdoor Alarm	Instant Burglar Outdoor Alarm	Instant Burglar Outdoor Alarm	Instant Burglar Alarm	No Response	Instant Burglar Outdoor Alarm
Cross Zone	See 10.3. Appendix – Cross Zone Verification			Instant Burglar Alarm	No Response	Delayed Burglar Alarm
Set/Unset (Opening)	Full Arm	No Response	Full Arm	Full Arm	No Response	No Response
Set/Unset (Closing)	No Response	Disarm	Disarm	Disarm	Disarm	Disarm
24H – Burglar	Instant Burglar Alarm	Instant Burglar Alarm	Instant Burglar Alarm	Instant Burglar Alarm	Instant Burglar Alarm	Instant Burglar Alarm
24H – Smoke	Instant Smoke	Instant Smoke	Instant Smoke	Instant Smoke	Instant Smoke	Instant Smoke Alarm

	Alarm	Alarm	Alarm	Alarm	Alarm	
24H – Medical	Instant Medical Alarm	Instant Medical Alarm	Instant Medical Alarm	Instant Medical Alarm	Instant Medical Alarm	Instant Medical Alarm
24H – Fire	Instant Fire Alarm	Instant Fire Alarm	Instant Fire Alarm	Instant Fire Alarm	Instant Fire Alarm	Instant Fire Alarm
24H – Water	Instant Water Alarm	Instant Water Alarm	Instant Water Alarm	Instant Water Alarm	Instant Water Alarm	Instant Water Alarm
24H – CO	Instant CO Alarm	Instant CO Alarm	Instant CO Alarm	Instant CO Alarm	Instant CO Alarm	Instant CO Alarm
24H – Gas	Instant Gas Alarm	Instant Gas Alarm	Instant Gas Alarm	Instant Gas Alarm	Instant Gas Alarm	Instant Gas Alarm
24H – Heat	Instant Heat Alarm	Instant Heat Alarm	Instant Heat Alarm	Instant Heat Alarm	Instant Heat Alarm	Instant Heat Alarm
24H – Silent Panic	Instant Silent Panic Alarm	Instant Silent Panic Alarm	Instant Silent Panic Alarm	Instant Silent Panic Alarm	Instant Silent Panic Alarm	Instant Silent Panic Alarm
24H – Panic	Instant Panic Alarm	Instant Panic Alarm	Instant Panic Alarm	Instant Panic Alarm	Instant Panic Alarm	Instant Panic Alarm
24H – Emergency	Instant Emergency Alarm	Instant Emergency Alarm	Instant Emergency Alarm	Instant Emergency Alarm	Instant Emergency Alarm	Instant Emergency Alarm
24H – Emergency (Quiet)	Instant Silent Emergency Alarm	Instant Silent Emergency Alarm	Instant Silent Emergency Alarm	Instant Silent Emergency Alarm	Instant Silent Emergency Alarm	Instant Silent Emergency Alarm
24H – Fire with Verification	See 10.4. Appendix – Fire Verification					
Trigger Scene	Trigger Scene Number	Trigger Scene Number	Trigger Scene Number	Trigger Scene Number	Trigger Scene Number	Trigger Scene Number

<NOTE>

- ☞ **“Delayed Burglar Alarm”** reponse means the Control Panel will wait for the Entry Time to expire. If the Entry Time expires without disarming the system, the Control Panel will activate a Burglar Alarm after Entry Time expiry.
- ☞ **“Silent Panic Alarm”, “Silent Emergency Alarm”** and **“Burglar Outdoor Alarm”** does not activate any audible alarm. The Control Panel will report the alarm event silently without any warning sound.

10.3. Cross Zone Verification

Cross Zone Verification is use to setup cross verification for intrusion sensors.

To use Cross Zone Verification, the following sensor and panel setting must be adjusted:

- 1 At least **1** intrusion sensor must be set to **Cross Zone** attribute.
- 2 The **Cross Zone Timer** option under Panel Setting webpage must be enabled.

Cross Zone Verification Rule

- Cross Zone function does not activate under Exit and Entry Time.
- When a sensor set to Cross Zone attribute is triggered, the panel begins to sound alarm, counts down Cross Zone Timer and reports a Cross Zone First Trip event (CID 693).
 - If the Cross Zone Timer expires without any other sensor trigger, the panel reports Cross Zone Trouble event (CID 378) when the timer expires.
 - If the same sensor is triggered again during Cross Zone Timers, the Cross Zone Timer is reset and extended.
 - If another sensor is triggered during the timer:
 - ☞ The Panel report Burglar (CID 130) for both sensors.
 - ☞ If the newly triggered sensor is set to Cross Zone attribute, the Panel also report Burglar Verified (CID 139) for this sensor.
 - ☞ The Cross Zone Timer is reset and extended.
 - ☞ When the Cross Zone Timer expires, the panel reports Cross Zone Timeout (CID 694).

10.4. Fire Verification

Fire Verification is use to setup verification for Smoke Detector.

To use Fire Verification, the following sensor and panel setting must be adjusted:

- 1 At least **1** Smoke Detector must be set to **24 HR – Fire with Verification** attribute.
- 2 The **Fire Verification Timer** option under Panel Setting webpage must be enabled.

Fire Verification Rule

- When a Smoke Detector set to Fire Verification attribute is triggered, the panel begins to sound alarm, counts down Fire Verification Timer and reports a Near Alarm event (CID 118).
 - Triggering any Smoke Detector with Fire Verification attribute (including the original Some Detector) during Fire Verification Timer will prompt panel to report Smoke Alarm event (CID 111), the timer will be reset and extended.
 - Triggering a regular Smoke Detector with Smoke attribute during the Fire Verification Timer will prompt panel to report Smoke Alarm event (CID 111), the timer will not be reset..
 - When the Fire Verification Timer expires, the panel reports Fire Verification Timeout event (CID 695).

10.5. Contact-ID Protocol & Format

Where	ACCT MT QXYZ GG C₁C₂C₃																				
ACCT	= 4 Digit Account number (0-9, B-F)																				
MT	= Message Type, 18H.																				
Q	= Event qualifier, which gives specific event information:																				
XYZ	= Event code (3 Hex digits 0-9, B-F)																				
GG	= Group, Partition number (00H), or Area Number - 00 = panel - 01= area 1.....xx= area xx																				
C ₁ C ₂ C ₃	= 1. For devices: zone																				
	<table border="1"> <tr> <td colspan="2">C₁C₂C₃ = Zone number</td> </tr> <tr> <td>001,</td> <td>Zone 1</td> </tr> <tr> <td>002,</td> <td>Zone 2</td> </tr> <tr> <td>.....</td> <td></td> </tr> <tr> <td>XXX</td> <td>Zone XXX</td> </tr> </table>	C₁C₂C₃ = Zone number		001,	Zone 1	002,	Zone 2		XXX	Zone XXX										
C₁C₂C₃ = Zone number																					
001,	Zone 1																				
002,	Zone 2																				
.....																					
XXX	Zone XXX																				
	2. For Panel: code																				
	<table border="1"> <tr> <td>C₁C₂C₃ =</td> <td></td> </tr> <tr> <td>User PIN Code 1</td> <td>001</td> </tr> <tr> <td>User PIN Code 2</td> <td>002</td> </tr> <tr> <td>User PIN Code 3</td> <td>003</td> </tr> <tr> <td>User PIN Code 4</td> <td>004</td> </tr> <tr> <td>User PIN Code 5</td> <td>005</td> </tr> <tr> <td>User PIN Code 6</td> <td>006</td> </tr> <tr> <td>Temporary Code</td> <td>997</td> </tr> <tr> <td>Duress Code</td> <td>998</td> </tr> <tr> <td colspan="2">000= Control Panel</td> </tr> </table>	C₁C₂C₃ =		User PIN Code 1	001	User PIN Code 2	002	User PIN Code 3	003	User PIN Code 4	004	User PIN Code 5	005	User PIN Code 6	006	Temporary Code	997	Duress Code	998	000= Control Panel	
C₁C₂C₃ =																					
User PIN Code 1	001																				
User PIN Code 2	002																				
User PIN Code 3	003																				
User PIN Code 4	004																				
User PIN Code 5	005																				
User PIN Code 6	006																				
Temporary Code	997																				
Duress Code	998																				
000= Control Panel																					

10.6. Event Code

- **100 – Medical**
 - ◆ When a device set to Medical attribute is triggered.
- **101 – Personal emergency**
 - ◆ When a device set to Personal Emergency attribute is triggered.
- **110 – Fire**
 - ◆ When a device set to Fire attribute is triggered.
- **111 – Smoke**
 - ◆ When the Smoke Detector (SD) set to Smoke Alarm is triggered.
 - ◆ When the Smoke Detector (SD) set to Fire Verification verifies an alarm during Fire Verification Time.
- **118 – Near Alarm**
 - ◆ When the Smoke Detector (SD) set to Fire Verification is triggered.
- **120 – Panic**
 - ◆ When a device set to Panic attribute is pressed.
- **121 – Duress**
 - ◆ When the Duress Code is entered to disarm or arm the system.
- **122 – Silent Panic**
 - ◆ When a device set to Silent Panic is pressed.
- **130 – Burglar**
 - ◆ Whenever a device set as Burglar Instant is triggered.
 - ◆ Whenever a device set as Burglar Instant is triggered under **Disarm, Full Arm** or **Home Arm** mode.
- **131 – Burglar Perimeter**
 - ◆ When a device set as **Entry** is triggered in Full Arm mode.
 - ◆ When a device set as **Burglar Follow** is triggered during Full Arm Entry Time and the system is not disarmed before entry time expiry.
- **132 – Burglar Interior**
 - ◆ When a device set at **Entry** is triggered in Home Arm mode.
 - ◆ When a device set as **Burglar Follow** is triggered during Home Arm Entry Time and the system is not disarmed before entry time expiry.
- **136 – Burglar Outdoor**
 - ◆ Whenever a device set at **Burglar Outdoor** is triggered.
- **137 – Panel Tamper/ Panel Tamper Restore**
 - ◆ When the panel's tamper protection is triggered.
 - ◆ When the panel's tamper function is restored.
- **139 – Burglar Verified.**
 - ◆ When a sensor set to Cross Zone attribute verifies an alarm.
- **147 – Sensor Supervision Failure/ Sensor Supervision Restore**
 - ◆ When the panel fails to receive supervision signal from a device within preset supervision timer.

- ◆ When the panel receives signal again from sensor that previously failed supervision.
- **154 – Water leakage**
 - ◆ When the Water Sensor connected to Door Contact set at **Water (@W)** is triggered.
- **158 – High Temperature Alarm**
 - ◆ When high temperature alarm is triggered.
- **159 – Low Temperature Alarm**
 - ◆ When low temperature alarm is triggered.
- **162 – CO Alarm**
- **170 – High Power Consumption**
 - ◆ When high power consumption alarm is triggered.
- **171 – High Humidity Alarm**
 - ◆ When high humidity alarm is triggered.
- **172 – Low Humidity Alarm**
 - ◆ When low humidity alarm is triggered.
- **301 – AC Failure/ AC Power Restore**
 - ◆ When the AC power fails for more than 10 sec.
 - ◆ Restore from AC power failure.
- **302 – Low battery/ Battery Normal**
 - ◆ When the battery voltage of the Panel is low.
 - ◆ When the panel battery restores voltage.
- **311 – Battery Disconnection/ Battery Reconnected**
- **344 – Interference/ Interference problem solved**
- **358 – Network Cable Unplugged**
 - ◆ When the Ethernet cable is disconnected.
- **374 – Force Arm**
 - ◆ When the system is armed with existing fault events
- **693 – Cross Zone Trouble**
 - ◆ When Cross Zone Timer expires without alarm verification.
- **380 – Device AC Failure**
 - ◆ When an AC power device loses AC power connection.
- **383 – Sensor Tamper/ Sensor Tamper Restore**
 - ◆ When any sensor's tamper protection is triggered.
 - ◆ When the sensor's tamper function is restored.
- **384 – Sensor Low battery/ Sensor Battery Normal**
 - ◆ When a device detects low battery voltage.
 - ◆ When a device's low battery condition is restored.
- **400 – Arm/Disarm (by Remote Controller)**
 - ◆ When the system is armed or disarmed by using the Remote Controller.
- **401 – Remote Arm/Disarm**
 - ◆ When the system is armed or disarmed by SMS message or web access

- **407 – Disarm/Away Arm/Home Arm by Remote Keypad**
- **408 – Set/Unset Arm/Disarm**
 - ◆ When the DC set at Set\Unset is triggered.
- **456 - Partial Arm**
 - ◆ When partially arm the system from Disarm to Home arm
- **570 – Device out of order/ Door Contact Not Closed**
 - ◆ When arm fault type is set as Direct Arm, any device is out of order after the preset exit delay time is reached
 - ◆ When arm fault type is set as Direct Arm, Door Contact is not closed after the preset exit delay time is reached.
- **602 – Periodic test report**
 - ◆ When the control panel makes periodic Check-in reporting.
- **616 – Call Request**
 - ◆ When the service call is activated by VST-809.
- **693 – Cross Zone First Trip**
 - ◆ When a sensor set to Cross Zone is triggered to start Cross Zone Timers.
- **694 – Cross Zone Timeout**
 - ◆ When Cross Zone Timer expires after the alarm has been verified.
- **695 – Fire Verification Timeout**
 - ◆ When Fire Verification Timer expires.

Federal Communication Commission Interference Statement

This equipment has been tested and found to comply with the limits for a Class B digital device, pursuant to Part 15 of the FCC Rules. These limits are designed to provide reasonable protection against harmful interference in a residential installation.

This equipment generates, uses and can radiate radio frequency energy and, if not installed and used in accordance with the instructions, may cause harmful interference to radio communications. However, there is no guarantee that interference will not occur in a particular installation. If this equipment does cause harmful interference to radio or television reception, which can be determined by turning the equipment off and on, the user is encouraged to try to correct the interference by one of the following measures:

- . Reorient or relocate the receiving antenna.
- . Increase the separation between the equipment and receiver.
- . Connect the equipment into an outlet on a circuit different from that to which the receiver is connected.
- . Consult the dealer or an experienced radio/TV technician for help.

FCC Caution: To assure continued compliance, any changes or modifications not expressly approved by the party responsible for compliance could void the user's authority to operate this equipment. (Example - use only shielded interface cables when connecting to computer or peripheral devices).

FCC Radiation Exposure Statement

This equipment complies with FCC RF radiation exposure limits set forth for an uncontrolled environment. This equipment should be installed and operated with a minimum distance of 20 centimeters between the radiator and your body.

This transmitter must not be co-located or operating in conjunction with any other antenna or transmitter.

The antennas used for this transmitter must be installed to provide a separation distance of at least 20 cm from all persons and must not be co-located or operating in conjunction with any other antenna or transmitter.

This device complies with Part 15 of the FCC Rules. Operation is subject to the following two conditions:

- (1) This device may not cause harmful interference, and
- (2) This device must accept any interference received, including interference that may cause undesired operation.